

19-430

Tax Collector's Certification

CTY-513

Tax Deed Application Number
1900099

Date of Tax Deed Application
Apr 12, 2019

This is to certify that **FCAP AS CUSTODIAN FOR FTCFIMT, LLC**
FL TAX CERT FUND I MUNI TAX, LLC, holder of **Tax Sale Certificate Number 2017 / 2619**, Issued the 1st Day of June, 2017
and which encumbers the following described property in the county of Escambia County, State of Florida, to wit: **05-5366-000**

Cert Holder:
FCAP AS CUSTODIAN FOR FTCFIMT, LLC
FL TAX CERT FUND I MUNI TAX, LLC
PO BOX 775311
CHICAGO, IL 60677

Property Owner:
KOUZMAN ROBERT DAR
1006 KEARNY DR
PENSACOLA, FL 32505

LT 10 BLK 22 1ST ADDN TO MAYFAIR PB 4 P 12 OR 7414 P 823

has surrendered same in my office and made written application for tax deed in accordance with Florida Statutes. I certify that the following tax certificates, interest, ownership and encumbrance report fee, and Tax Collector's fees have been paid, or if the certificate is held by the County, all appropriate fees have been deposited.

Certificates owned by applicant and filed in connection with this application:

Certificate Year/Number	Account Number	Sale Date	Face Amount of Certificate	Interest	Total
2017/2619	05-5366-000	06/01/2017	731.03	36.55	767.58

Certificates redeemed by applicant or included (County) in connection with this tax deed application:

Certificate Year/Number	Account Number	Sale Date	Face Amount of Certificate	Tax Collector's Fee	Interest	Total
2018/2706	05-5366-000	06/01/2018	636.07	6.25	45.19	687.51

Amounts Certified by Tax Collector (Lines 1-7):

Total Amount Paid

1. Total of all Certificates in Applicant's Possession and Cost of the Certificates Redeemed by Applicant	1,455.09
2. Total of Delinquent Taxes Paid by Tax Deed Applicant	0.00
3. Total of Current Taxes Paid by Tax Deed Applicant	333.52
4. Property Information Report Fee	200.00
5. Tax Deed Application Fee	175.00
6. Total Interest Accrued by Tax Collector Pursuant to Section 197.542, F.S.	
7. Total (Lines 1 - 6)	2,163.61

Amounts Certified by Clerk of Court (Lines 8-15):

Total Amount Paid

8. Clerk of Court Statutory Fee for Processing Tax Deed	
9. Clerk of Court Certified Mail Charge	
10. Clerk of Court Advertising Charge	
11. Clerk of Court Recording Fee for Certificate of Notice	
12. Sheriff's Fee	
13. Interest Computed by Clerk of Court Pursuant to Section 197.542, F.S.	
14. Total (Lines 8 - 13)	
15. One-half Assessed Value of Homestead Property, if Applicable per F.S.	18,134.00
16. Other Outstanding Certificates and Delinquent Taxes Not Included in this Application, If Applicable Per Florida Statutes	
17. Statutory (Opening) Bid; Total of Lines 7, 14, 15 (if applicable) and 16 (if applicable)	
18. Redemption Fee	6.25
19. Total Amount to Redeem	

Done this the 23rd day of April, 2019 Scott Lunsford, Tax Collector of Escambia County

Date of Sale: September 3, 2019

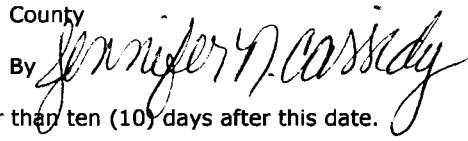
By 

*This certification must be surrendered to the Clerk of the Circuit Court no later than ten (10) days after this date.
05-5366-000 2017

APPLICATION FOR TAX DEED

Section 197.502, Florida Statutes

512
R. 12/16

Application Number: 1900099

To: Tax Collector of ESCAMBIA COUNTY, Florida

I,
FCAP AS CUSTODIAN FOR FTCFIMT, LLC
FL TAX CERT FUND I MUNI TAX, LLC
PO BOX 775311
CHICAGO, IL 60677,

hold the listed tax certificate and hereby surrender the same to the Tax Collector and make tax deed application thereon:

Account Number	Certificate No.	Date	Legal Description
05-5366-000	2017/2619	06-01-2017	LT 10 BLK 22 1ST ADDN TO MAYFAIR PB 4 P 12 OR 7414 P 823

I agree to:

- pay any current taxes, if due and
- redeem all outstanding tax certificates plus interest not in my possession, and
- pay all delinquent and omitted taxes, plus interest covering the property.
- pay all Tax Collector's fees, property information report costs, Clerk of the Court costs, charges and fees, and Sheriff's costs, if applicable.

Attached is the tax sale certificate on which this application is based and all other certificates of the same legal description which are in my possession.

Electronic signature on file
FCAP AS CUSTODIAN FOR FTCFIMT, LLC
FL TAX CERT FUND I MUNI TAX, LLC
PO BOX 775311
CHICAGO, IL 60677

04-12-2019
Application Date

Applicant's signature



Chris Jones
Escambia County Property Appraiser

Real Estate Search Tangible Property Search Sale List

[Back](#)

◀ Navigate Mode Account Reference ▶

[Printer Friendly Version](#)

<p>General Information</p> <p>Reference: 152S301000010023 Account: 055366000 Owners: KOUZMAN ROBERT DAR Mail: 1006 KEARNY DR PENSACOLA, FL 32505 Situs: 1006 KEARNY DR 32505 Use Code: SINGLE FAMILY RESID </p> <p>Taxing Authority: COUNTY MSTU Tax Inquiry: Open Tax Inquiry Window Tax Inquiry link courtesy of Scott Lunsford Escambia County Tax Collector</p>	<p>Assessments</p> <table border="1"> <thead> <tr> <th>Year</th> <th>Land</th> <th>Imprv</th> <th>Total</th> <th>Cap Val</th> </tr> </thead> <tbody> <tr> <td>2018</td> <td>\$4,500</td> <td>\$31,768</td> <td>\$36,268</td> <td>\$36,268</td> </tr> <tr> <td>2017</td> <td>\$4,500</td> <td>\$22,422</td> <td>\$26,922</td> <td>\$26,922</td> </tr> <tr> <td>2016</td> <td>\$4,500</td> <td>\$28,101</td> <td>\$32,601</td> <td>\$32,601</td> </tr> </tbody> </table> <p style="text-align: center;">Disclaimer</p> <hr/> <p style="text-align: center;">Tax Estimator</p> <hr/> <p style="text-align: center;">> File for New Homestead Exemption Online</p>	Year	Land	Imprv	Total	Cap Val	2018	\$4,500	\$31,768	\$36,268	\$36,268	2017	\$4,500	\$22,422	\$26,922	\$26,922	2016	\$4,500	\$28,101	\$32,601	\$32,601
Year	Land	Imprv	Total	Cap Val																	
2018	\$4,500	\$31,768	\$36,268	\$36,268																	
2017	\$4,500	\$22,422	\$26,922	\$26,922																	
2016	\$4,500	\$28,101	\$32,601	\$32,601																	

<p>Sales Data</p> <table border="1"> <thead> <tr> <th>Sale Date</th> <th>Book</th> <th>Page</th> <th>Value</th> <th>Type</th> <th>Official Records (New Window)</th> </tr> </thead> <tbody> <tr> <td>10/01/2015</td> <td>7414</td> <td>823</td> <td>\$7,000</td> <td>QC</td> <td>View Instr</td> </tr> <tr> <td>02/22/2012</td> <td>6826</td> <td>1982</td> <td>\$16,000</td> <td>WD</td> <td>View Instr</td> </tr> <tr> <td>10/24/2011</td> <td>6778</td> <td>977</td> <td>\$100</td> <td>CJ</td> <td>View Instr</td> </tr> <tr> <td>09/01/2011</td> <td>6782</td> <td>338</td> <td>\$100</td> <td>CJ</td> <td>View Instr</td> </tr> <tr> <td>07/21/2011</td> <td>6743</td> <td>1876</td> <td>\$100</td> <td>OT</td> <td>View Instr</td> </tr> <tr> <td>09/1986</td> <td>2274</td> <td>1</td> <td>\$38,900</td> <td>WD</td> <td>View Instr</td> </tr> <tr> <td>01/1976</td> <td>1040</td> <td>319</td> <td>\$21,500</td> <td>WD</td> <td>View Instr</td> </tr> <tr> <td>01/1967</td> <td>368</td> <td>340</td> <td>\$10,900</td> <td>WD</td> <td>View Instr</td> </tr> </tbody> </table> <p>Official Records Inquiry courtesy of Pam Childers Escambia County Clerk of the Circuit Court and Comptroller</p>	Sale Date	Book	Page	Value	Type	Official Records (New Window)	10/01/2015	7414	823	\$7,000	QC	View Instr	02/22/2012	6826	1982	\$16,000	WD	View Instr	10/24/2011	6778	977	\$100	CJ	View Instr	09/01/2011	6782	338	\$100	CJ	View Instr	07/21/2011	6743	1876	\$100	OT	View Instr	09/1986	2274	1	\$38,900	WD	View Instr	01/1976	1040	319	\$21,500	WD	View Instr	01/1967	368	340	\$10,900	WD	View Instr	<p>2018 Certified Roll Exemptions HOMESTEAD EXEMPTION</p> <hr/> <p>Legal Description LT 10 BLK 22 1ST ADDN TO MAYFAIR PB 4 P 12 OR 7414 P 823</p> <hr/> <p>Extra Features None</p>
Sale Date	Book	Page	Value	Type	Official Records (New Window)																																																		
10/01/2015	7414	823	\$7,000	QC	View Instr																																																		
02/22/2012	6826	1982	\$16,000	WD	View Instr																																																		
10/24/2011	6778	977	\$100	CJ	View Instr																																																		
09/01/2011	6782	338	\$100	CJ	View Instr																																																		
07/21/2011	6743	1876	\$100	OT	View Instr																																																		
09/1986	2274	1	\$38,900	WD	View Instr																																																		
01/1976	1040	319	\$21,500	WD	View Instr																																																		
01/1967	368	340	\$10,900	WD	View Instr																																																		

Parcel Information [Launch Interactive Map](#)

Section Map Id: 15-2S-30-1

Approx. Acreage: 0.2012

Zoned: MDR

Evacuation & Flood Information
[Open Report](#)

[View Florida Department of Environmental Protection \(DEP\) Data](#)

Buildings

Address: 1006 KEARNY DR, Year Built: 1957, Effective Year: 1957

Structural Elements	
DECOR/MILLWORK-AVERAGE	

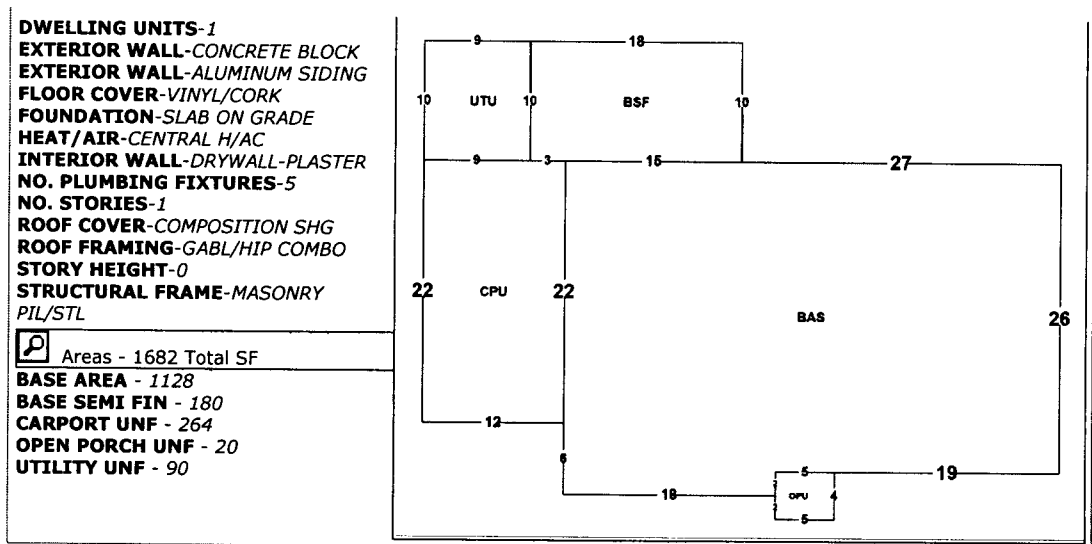

Images

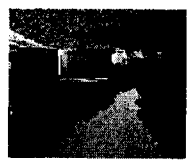

1/7/13

The primary use of the assessment data is for the preparation of the current year tax roll. No responsibility or liability is assumed for inaccuracies or errors.

Last Updated:04/25/2019 (tc.4835)

19-430



PAM CHILDERS
CLERK OF THE CIRCUIT COURT
ESCAMBIA COUNTY, FLORIDA

Tax Deed - Redemption Calculator

Account: 055366000 Certificate Number: 002619 of 2017

Redemption No Application Date Interest Rate

Final Redemption Payment ESTIMATED

Redemption Overpayment ACTUAL

Auction Date

Redemption Date

Months	5	0
Tax Collector	<input type="text" value="\$2,163.61"/>	<input type="text" value="\$2,163.61"/>
Tax Collector Interest	\$162.27	\$0.00
Tax Collector Fee	<input type="text" value="\$6.25"/>	<input type="text" value="\$6.25"/>
Total Tax Collector	\$2,332.13	\$2,169.86 <i>T.C.</i>
Record TDA Notice	<input type="text" value="\$17.00"/>	<input type="text" value="\$17.00"/>
Clerk Fee	<input type="text" value="\$130.00"/>	<input type="text" value="\$130.00"/>
Sheriff Fee	<input type="text" value="\$120.00"/>	<input type="text" value="\$120.00"/>
Legal Advertisement	<input type="text" value="\$200.00"/>	<input type="text" value="\$200.00"/>
App. Fee Interest	\$35.03	\$0.00
Total Clerk	\$502.03	\$467.00 <i>C.H.</i>
Release TDA Notice (Recording)	<input type="text" value="\$10.00"/>	<input type="text" value="\$10.00"/>
Release TDA Notice (Prep Fee)	<input type="text" value="\$7.00"/>	<input type="text" value="\$7.00"/>
Postage	<input type="text" value="\$60.00"/>	<input type="text" value="\$0.00"/>
Researcher Copies	<input type="text" value="\$40.00"/>	<input type="text" value="\$0.00"/>
Total Redemption Amount	\$2,951.16	\$2,653.86
	Repayment Overpayment Refund Amount	\$297.30
Book/Page	<input type="text"/>	<input type="text"/>

Notes

19-430

PAM CHILDERS
 CLERK OF THE CIRCUIT COURT
 ARCHIVES AND RECORDS
 CHILDSUPPORT
 CIRCUIT CIVIL
 CIRCUIT CRIMINAL
 COUNTY CIVIL
 COUNTY CRIMINAL
 DOMESTIC RELATIONS
 FAMILY LAW
 JURY ASSEMBLY
 JUVENILE
 MENTAL HEALTH
 MIS
 OPERATIONAL SERVICES
 PROBATE
 TRAFFIC



**COUNTY OF ESCAMBIA
 OFFICE OF THE
 CLERK OF THE CIRCUIT COURT**

**BRANCH OFFICES
 ARCHIVES AND RECORDS
 JUVENILE DIVISION
 CENTURY**

CLERK TO THE BOARD OF
 COUNTY COMMISSIONERS
 OFFICIAL RECORDS
 COUNTY TREASURY
 AUDITOR

**PAM CHILDERS, CLERK OF THE CIRCUIT COURT
 Tax Certificate Redeemed From Sale
 Account: 055366000 Certificate Number: 002619 of 2017**

Payor: ROBERT DAR KOUZMAN 1006 KEARNY DR PENSACOLA, FL 32505 Date 04/29/2019

Clerk's Check #	1	Clerk's Total	\$502.03
Tax Collector Check #	1	Tax Collector's Total	\$2,332.13
		Postage	\$60.00
		Researcher Copies	\$0.00
		Recording	\$10.00
		Prep Fee	\$7.00
		Total Received	\$2,911.16 \$2,333.86

**PAM CHILDERS
 Clerk of the Circuit Court**

Received By: *N Coppinger*
 Deputy Clerk

**Escambia County Government Complex • 221 Palafox Place Ste 110 • PENSACOLA, FLORIDA 32502
 (850) 595-3793 • FAX (850) 595-4827 • <http://www.clerk.co.escambia.fl.us>**

19-430

PAM CHILDERS
 CLERK OF THE CIRCUIT COURT
 ARCHIVES AND RECORDS
 CHILDSUPPORT
 CIRCUIT CIVIL
 CIRCUIT CRIMINAL
 COUNTY CIVIL
 COUNTY CRIMINAL
 DOMESTIC RELATIONS
 FAMILY LAW
 JURY ASSEMBLY
 JUVENILE
 MENTAL HEALTH
 MIS
 OPERATIONAL SERVICES
 PROBATE
 TRAFFIC

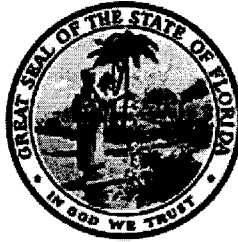

BRANCH OFFICES
ARCHIVES AND RECORDS
JUVENILE DIVISION
CENTURY

CLERK TO THE BOARD OF
 COUNTY COMMISSIONERS
 OFFICIAL RECORDS
 COUNTY TREASURY
 AUDITOR

COUNTY OF ESCAMBIA
OFFICE OF THE
CLERK OF THE CIRCUIT COURT

Case # 2017 TD 002619

Redeemed Date 04/29/2019

Name ROBERT DAR KOUZMAN 1006 KEARNY DR PENSACOLA, FL 32505

Clerk's Total = TAXDEED	\$502.03	} \$2,316.86
Due Tax Collector = TAXDEED	\$2,332.13	
Postage = TD2	\$60.00	
ResearcherCopies = TD6	\$0.00	
Release TDA Notice (Recording) = RECORD2	\$10.00	
Release TDA Notice (Prep Fee) = TD4	\$7.00	

• For Office Use Only

Date	Docket	Desc	Amount Owed	Amount Due	Payee Name
------	--------	------	-------------	------------	------------

FINANCIAL SUMMARY

No Information Available - See Dockets

NOTICE OF APPLICATION FOR TAX DEED

NOTICE IS HEREBY GIVEN, That **FCAP AS CUSTODIAN FOR FTCFIMT LLC FL TAX CERT FUND I MUNI TAX LLC** holder of **Tax Certificate No. 02619**, issued the **1st day of June, A.D., 2017** has filed same in my office and has made application for a tax deed to be issued thereon. Said certificate embraces the following described property in the County of Escambia, State of Florida, to wit:

LT 10 BLK 22 1ST ADDN TO MAYFAIR PB 4 P 12 OR 7414 P 823

SECTION 15, TOWNSHIP 2 S, RANGE 30 W

TAX ACCOUNT NUMBER 055366000 (19-430)

The assessment of the said property under the said certificate issued was in the name of

ROBERT DAR KOUZMAN

Unless said certificate shall be redeemed according to law, the property described therein will be sold to the highest bidder at public auction at 9:00 A.M. on the **first** Tuesday in the month of September, which is the **3rd day of September 2019**.

Dated this 26th day of April 2019.

In accordance with the AMERICANS WITH DISABILITIES ACT, if you are a person with a disability who needs special accommodation in order to participate in this proceeding you are entitled to the provision of certain assistance. Please contact Emily Hogg not later than seven days prior to the proceeding at Escambia County Government Complex, 221 Palafox Place Ste 110, Pensacola FL 32502. Telephone: 850-595-3793.

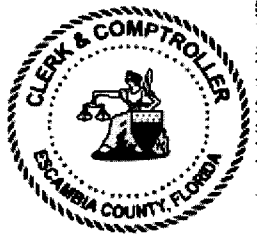

PAM CHILDERS
CLERK OF THE CIRCUIT COURT
ESCAMBIA COUNTY, FLORIDA

By:
Emily Hogg
Deputy Clerk

RELEASE OF NOTICE OF APPLICATION FOR TAX DEED

Pursuant to § 197.502(5)(c), Florida Statutes, the Escambia County Clerk of Court fully releases the Notice of Tax Deed Application recorded at Official Records Book 8086, Page 402, of Escambia County, for the tax certificate, tax deed, and property described below:

Tax Certificate No. Certificate No. 02619, issued the 1st day of June, A.D., 2017

TAX ACCOUNT NUMBER: **055366000 (19-430)**

DESCRIPTION OF PROPERTY:

LT 10 BLK 22 1ST ADDN TO MAYFAIR PB 4 P 12 OR 7414 P 823

SECTION 15, TOWNSHIP 2 S, RANGE 30 W

NAME IN WHICH ASSESSED: ROBERT DAR KOUZMAN

Dated this 30th day of April 2019.



PAM CHILDERS
CLERK OF THE CIRCUIT COURT
ESCAMBIA COUNTY, FLORIDA

By:
Emily Hogg
Deputy Clerk



Pam Childers

Clerk of the Circuit Court and Comptroller, Escambia County

Clerk of Courts • County Comptroller • Clerk of the Board of County Commissioners • Recorder •

May 7, 2019

FCAP AS CUSTODIAN FOR FTCFIMT LLC
PO BOX 775311
CHICAGO IL 60677

Dear Certificate Holder:

The records of this office show that an application for a tax deed had been made on the property represented by the numbered certificate listed below. The property redeemed prior to sale; therefore your application fees are now refundable.

TAX CERT	APP FEES	INTEREST	TOTAL
2017 TD 002619	\$467.00	\$0.00	\$467.00
2017 TD 006780	\$467.00	\$0.00	\$467.00
2017 TD 003932	\$467.00	\$0.00	\$467.00
2017 TD 006042	\$467.00	\$0.00	\$467.00
2017 TD 008163	\$467.00	\$7.01	\$474.01

TOTAL \$2,342.01

Very truly yours,

PAM CHILDERS
Clerk of Circuit Court

By:

Emily Hogg
Tax Deed Division

Southern Guaranty Title Company

4400 Bayou Boulevard, Suite 13B

Pensacola, Florida 32503

Telephone: 850-478-8121

Facsimile: 850-476-1437

19-430

Redeemed

PROPERTY INFORMATION REPORT

File No.: 15166

May 7, 2019

Escambia County Tax Collector
P.O. Box 1312
Pensacola, Florida 32591

Pursuant to your request, the Company has caused a search to be made of the Public Records of Escambia County, Florida, solely as revealed by records maintained from 05-07-1999, through 05-07-2019, and said search reveals the following:

1. THE GRANTEE(S) OF THE LAST DEED(S) OF RECORD IS:

Robert Dar Kouzman

2. The land covered by this Report is:

LEGAL DESCRIPTION IS ATTACHED HERETO AND MADE A PART HEREOF

3. The following unsatisfied mortgages, liens and judgments affecting the land covered by this Report appear of record:

SEE CONTINUATION PAGE ATTACHED HERETO AND MADE A PART HEREOF

4. Taxes:

SEE CONTINUATION PAGE ATTACHED HERETO AND MADE A PART HEREOF

This report is not title insurance. Pursuant to s. 627.7843, Florida Statutes, the maximum liability of the issuer of this property information report for errors or omissions in this property information report is limited to the amount paid for this property information report, and is further limited to the person(s) expressly identified by name in the property information report as the recipients(s) of the property information report.

THIS REPORT SHALL NOT BE USED FOR THE ISSUANCE OF TITLE INSURANCE.

Southern Guaranty Title Company

By: 

May 7, 2019

**PROPERTY INFORMATION REPORT
LEGAL DESCRIPTION**

File No.: 15166

May 7, 2019

Lot 10, Block 22, First Addition to Mayfair, as per plat thereof, recorded in Plat Book 4, Page 12, of the Public Records of Escambia County, Florida

**PROPERTY INFORMATION REPORT
CONTINUATION PAGE**

File No.: 15166

May 7, 2019

UNSATISFIED MORTGAGES, LIENS AND JUDGMENTS AFFECTING THE LAND COVERED BY THIS REPORT THAT APPEAR OF RECORD:

1. Utility Lien filed by ECUA in O.R. Book 8043, page 174.
2. Code Enforcement Lien filed by Escambia County in O.R. Book 7884, page 1011.
3. Taxes for the year 2016-2018 delinquent. The assessed value is \$36,268.00. Tax ID 05-5366-000.

PLEASE NOTE THE FOLLOWING:

- A. Subject to current year taxes.
- B. Taxes and assessments due now or in subsequent years.
- C. Subject to Easements, Restrictions and Covenants of record.
- D. Encroachments, overlaps, boundary line disputes, and any other matters which would be disclosed by an accurate survey and inspection of the premises.
- E. Oil, gas and mineral or any other subsurface rights of any kind or nature.

SOUTHERN GUARANTY TITLE COMPANY

4400 BAYOU BLVD., SUITE 13-B, CORDOVA SQUARE

PENSACOLA, FLORIDA 32503

TEL. (850) 478-8121 FAX (850) 476-1437

Email: rcsgt@aol.com

Scott Lunsford
Escambia County Tax Collector
P.O. Box 1312
Pensacola, FL 32591

CERTIFICATION: TITLE SEARCH FOR TDA

TAX DEED SALE DATE: 9-3-2019

TAX ACCOUNT NO.: 05-5366-000

CERTIFICATE NO.: 2017-2619

In compliance with Section 197.256, Florida Statutes, the following is a list of names and addresses of those persons, firms and/or agencies having legal interest in or claim against the above described property. The above referenced tax sale certificate is being submitted as proper notification of tax deed sale.

YES NO

- Notify City of Pensacola, P.O. Box 12910, 32521
221 Palafox Place, 4th Floor/
 Notify Escambia County, 190 Governmental Center, 32502
 Homestead for 2018 tax year.

Robert Dar Kouzman
1006 Kearny Dr.
Pensacola, FL 32505

ECUA
9255 Sturdevant St.
Pensacola, FL 32514

Escambia County Code Enforcement
3363 West Park Place
Pensacola, FL 32505

Certified and delivered to Escambia County Tax Collector,
this 7th day of May, 2019.

SOUTHERN GUARANTY TITLE COMPANY

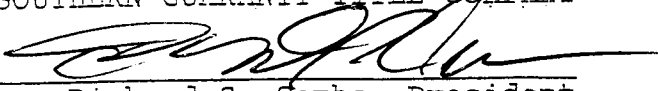
by: Richard S. Combs, President

NOTE: The above listed addresses are based upon current information available, but said addresses are not guaranteed to be true or correct.

Prepared By:
Harold Bergeron
H.J. Bergeron Corporation
857 Brownswitch Road #322
Slidell, LA 70458

QUIT CLAIM DEED

Property Appraiser's Parcel Identification No. 152S301000010023

This Quit Claim Deed, Executed this 1st day of October, 2015,

Between H. J. Bergeron Corporation, a Louisiana corporation, whose mailing address is 857 Brownswitch Road #322, Slidell, LA 70458, hereinafter referred to as First Party, and Robert Dar Kouzman, a single man, whose mailing address is 203 Quina Way, Pensacola, FL 32505, hereinafter referred to as Second Party,

Witnesseth, That the said First Party, for and in consideration of the sum of TEN DOLLARS (\$10.00), in hand paid by the said Second Party, the receipt whereof is hereby acknowledged, does hereby remise, release and quit-claim unto the said Second Party forever, all the right, title, interest, claim and demand which the said First Party has in and to the following described lot, piece or parcel land, situate, lying and being in the County of Escambia, State of Florida To Wit:

Lot 10, Block 22, First Addition to Mayfair, a subdivision of a portion of Section 15, Township 2 South, Range 30 West, Escambia County, Florida, according to the plat thereof, recorded in Plat Book 4, Page(s) 12, of the Public Records of said County.

Subject to covenants, restrictions, easements of record and taxes for the current year and thereafter.

To have and to hold the same together with all and singular the appurtenances thereunto belonging or in anywise appertaining, and all the estate, right, title, interest, lien, equity and claim whatsoever for the said First Party, either in law or equity, to the only proper use, benefit and behoof of the said Second Party forever.

In Witness Whereof, the said First Party has signed and sealed these presents the day and year first above written.

Signed, sealed, and delivered in the presence of:

James C Godwin
Witness Signature as to First Party

James C Godwin
Printed Name

Harold J Bergeron
By: Harold Bergeron, Director H.J. Bergeron Corp.
857 Brownswitch Road #322
Slidell, LA 70458

Kathryn C O'Gwynn
Witness Signature as to First Party

Kathryn C O'Gwynn
Printed Name

1006 KEARNY DRIVE
PENSACOLA, FL. 32505

STATE OF FLORIDA
COUNTY OF ESCAMBIA

The foregoing instrument was acknowledged before me this 1st day of Oct, 2015, by Harold Bergeron, as Director of H.J. Bergeron Corporation, who is personally known to me or has produced FL DL as identification and who did/did not take an oath.

Kathryn C O'Gwynn
Signature of Notary/Deputy Clerk
Kathryn C O'Gwynn
Printed Name

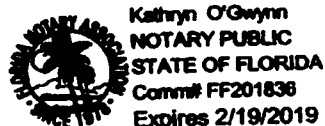

**THE OFFICE OF ENVIRONMENTAL ENFORCEMENT
SPECIAL MAGISTRATE
IN AND FOR THE
COUNTY OF ESCAMBIA, STATE OF FLORIDA**

PETITIONER
ESCAMBIA COUNTY FLORIDA,

VS.

**CASE NO: CE#17-09-04267
LOCATION: 1006 Kearny Dr
PR# 152S301000010023**

**Kouzman, Robert Dar
203 Quina Way
Pensacola, FL 32505
RESPONDENT**

ORDER

This CAUSE having come before the Office of Environmental Enforcement Special Magistrate on the Petition of the Environmental Enforcement Officer for alleged violation of the ordinances of the County of Escambia, State of Florida, and the Special Magistrate having considered the evidence before him in the form of testimony by the Enforcement Officer and the Respondent or representative, thereof, Robert Kouzman, as well as evidence submitted and after consideration of the appropriate sections of the Escambia County Code of Ordinances, the Special Magistrate finds that a violation of the following Code of Ordinance(s) has occurred and continues

- 42-196 (a) Nuisance Conditions
- 42-196 (b) Trash and Debris
- 42-196 (c) Inoperable Vehicle(s); Described _____

42-196 (d) Overgrowth

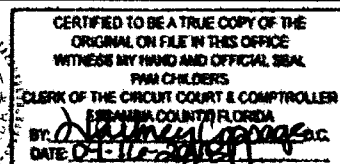
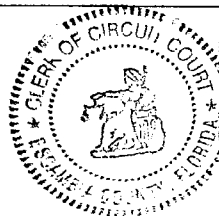

This Instrument Was Prepared
By And Is To Be Returned To:
Cassandra Strickland,
Emerald Coast Utilities Authority
9255 Sturdevant Street
Pensacola, Florida 32514-0311



NOTICE OF LIEN

**STATE OF FLORIDA
COUNTY OF ESCAMBIA**

Notice is hereby given that the EMERALD COAST UTILITES AUTHORITY has a lien against the following described real property situated in Escambia County, Florida, for water, wastewater and/or sanitation service provided to the following customer:
LT 10 BLK 22 1ST ADDN TO MAYFAIR PB 4 P 12 OR 7414 P 823

Customer: Robert Kouzman

Account Number: 237386-51414

Amount of Lien: \$ 193.03, together with additional unpaid utility service charges, if any, which may accrue subsequent to the date of this notice and simple interest on unpaid charges at 18 percent per annum, or at such lesser rate as may be allowed by law.

This lien is imposed in accordance with Section 159.17, Florida Statutes, Chapter 92-248, Laws of Florida, as amended and Emerald Coast Utilities Authority Resolution 87-10, as amended, and this lien shall be prior to all other liens on such lands or premises except the lien of state, county, and municipal taxes and shall be on a parity with the lien of such state, county, and municipal taxes.

Provided however, that if the above-named customer has conveyed said property by means of deed recorded in the public records of Escambia County, Florida, prior to the recording of this instrument, or if the interest of the above-named customer is foreclosed by a proceeding in which notice of lis pendens has been filed prior to the recording of this instrument, this lien shall be void and of no effect.

Dated: February 5, 2019

EMERALD COAST UTILITIES AUTHORITY

BY: Cassandra Strickland

**STATE OF FLORIDA
COUNTY OF ESCAMBIA**

The foregoing instrument was acknowledged before me this 5th day of February, 2019, by Cassandra Strickland of the Emerald Coast Utilities Authority, who is personally known to me and who did not take an oath.

John W. Gaines, III
Notary Public
State of Florida
My Commission Expires June 25, 2021
Commission No. 118462

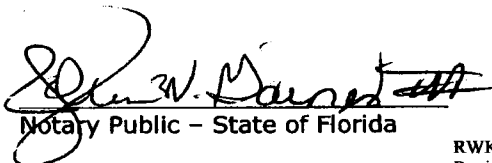
Notary Public - State of Florida

RWK:ls
Revised 05/31/11