

19-445

# Tax Collector's Certification

CTY-513

**Tax Deed Application Number**  
1900148

**Date of Tax Deed Application**  
Apr 17, 2019

This is to certify that **CATALINA TAX CO LLC SERIES 17 US BANK % CATALINA TAX -SER 17**, holder of **Tax Sale Certificate Number 2017 / 459**, Issued the 1st Day of June, 2017 and which encumbers the following described property in the county of Escambia County, State of Florida, to wit: **02-0089-020**

**Cert Holder:**  
**CATALINA TAX CO LLC SERIES 17 US BANK % CATALINA TAX -SER 17**  
**PO BOX 645040**  
**CINCINNATI, OH 45264-5040**

**Property Owner:**  
**NIMS JAMES D & NIMS AMBER**  
**1591 REBECCA ST**  
**PENSACOLA, FL 32534**  
S 165 FT OF W 125 FT OF S 1/2 OF SE 1/4 OF NE 1/4 OF NW 1/4 OR 5526 P 231 OR 7131 P 1616 OR 7131 P 1 (Full legal attached.)

has surrendered same in my office and made written application for tax deed in accordance with Florida Statutes. I certify that the following tax certificates, interest, ownership and encumbrance report fee, and Tax Collector's fees have been paid, or if the certificate is held by the County, all appropriate fees have been deposited.

Certificates owned by applicant and filed in connection with this application:

Certificate Year/Number	Account Number	Sale Date	Face Amount of Certificate	Interest	Total
2017/459	02-0089-020	06/01/2017	1,456.02	72.80	1,528.82

Certificates redeemed by applicant or included (County) in connection with this tax deed application:

Certificate Year/Number	Account Number	Sale Date	Face Amount of Certificate	Tax Collector's Fee	Interest	Total
2018/471	02-0089-020	06/01/2018	1,469.92	6.25	73.50	1,549.67

**Amounts Certified by Tax Collector (Lines 1-7):**

**Total Amount Paid**

1. Total of all Certificates in Applicant's Possession and Cost of the Certificates Redeemed by Applicant	3,078.49
2. Total of Delinquent Taxes Paid by Tax Deed Applicant	0.00
3. Total of Current Taxes Paid by Tax Deed Applicant	1,357.97
4. Property Information Report Fee	200.00
5. Tax Deed Application Fee	175.00
6. Total Interest Accrued by Tax Collector Pursuant to Section 197.542, F.S.	
7. Total (Lines 1 - 6)	4,811.46

**Amounts Certified by Clerk of Court (Lines 8-15):**

**Total Amount Paid**

8. Clerk of Court Statutory Fee for Processing Tax Deed	
9. Clerk of Court Certified Mail Charge	
10. Clerk of Court Advertising Charge	
11. Clerk of Court Recording Fee for Certificate of Notice	
12. Sheriff's Fee	
13. Interest Computed by Clerk of Court Pursuant to Section 197.542, F.S.	
14. Total (Lines 8 - 13)	
15. One-half Assessed Value of Homestead Property, if Applicable per F.S.	61,912.00
16. Other Outstanding Certificates and Delinquent Taxes Not Included in this Application,	
17. Statutory (Opening) Bid; Total of Lines 7, 14, 15 (if applicable) and 16 (if	
18. Redemption Fee	6.25
19. Total Amount to Redeem	

Done this the 24th day of April, 2019 Scott Lunsford, Tax Collector of Escambia County

Date of Sale: 9-3-19

By 

\*This certification must be surrendered to the Clerk of the Circuit Court no later than ten (10) days after this date.  
02-0089-020 2017

S 165 FT OF W 125 FT OF S 1/2 OF SE 1/4 OF NE 1/4 OF NW 1/4 OR 5526 P 231 OR 7131 P 1616 OR 7131 P 1618 PART OF LT 13

**APPLICATION FOR TAX DEED**  
Section 197.502, Florida Statutes

512  
R. 12/16

Application Number: 1900148

To: Tax Collector of ESCAMBIA COUNTY, Florida

I,  
CATALINA TAX CO LLC SERIES 17 US BANK % CATALINA TAX -SER 17  
PO BOX 645040  
CINCINNATI, OH 45264-5040,

hold the listed tax certificate and hereby surrender the same to the Tax Collector and make tax deed application thereon:

Account Number	Certificate No.	Date	Legal Description
02-0089-020	2017/459	06-01-2017	S 165 FT OF W 125 FT OF S 1/2 OF SE 1/4 OF NE 1/4 OF NW 1/4 OR 5526 P 231 OR 7131 P 1616 OR 7131 P 1618 PART OF LT 13 BLK 3 PLAT DB 89 PG 369

I agree to:

- pay any current taxes, if due and
- redeem all outstanding tax certificates plus interest not in my possession, and
- pay all delinquent and omitted taxes, plus interest covering the property.
- pay all Tax Collector's fees, property information report costs, Clerk of the Court costs, charges and fees, and Sheriff's costs, if applicable.

Attached is the tax sale certificate on which this application is based and all other certificates of the same legal description which are in my possession.

Electronic signature on file  
CATALINA TAX CO LLC SERIES 17 US BANK %  
CATALINA TAX -SER 17  
PO BOX 645040  
CINCINNATI, OH 45264-5040

04-17-2019  
Application Date

\_\_\_\_\_  
Applicant's signature



Chris Jones  
Escambia County Property Appraiser

Real Estate Search    Tangible Property Search    Sale List

[Back](#)

Navigate Mode   
  Account   
  Reference

[Printer Friendly Version](#)

<p><b>General Information</b></p> <p><b>Reference:</b> 101S301101132003</p> <p><b>Account:</b> 020089020</p> <p><b>Owners:</b> NIMS JAMES D &amp; NIMS AMBER</p> <p><b>Mail:</b> 1591 REBECCA ST PENSACOLA, FL 32534</p> <p><b>Situs:</b> 1591 REBECCA ST 32534</p> <p><b>Use Code:</b> SINGLE FAMILY RESID</p> <p><b>Taxing Authority:</b> COUNTY MSTU</p> <p><b>Tax Inquiry:</b> <a href="#">Open Tax Inquiry Window</a> Tax Inquiry link courtesy of Scott Lunsford Escambia County Tax Collector</p>	<p><b>Assessments</b></p> <table border="1"> <thead> <tr> <th>Year</th> <th>Land</th> <th>Imprv</th> <th>Total</th> <th>Cap Val</th> </tr> </thead> <tbody> <tr> <td>2018</td> <td>\$20,093</td> <td>\$129,411</td> <td>\$149,504</td> <td>\$123,824</td> </tr> <tr> <td>2017</td> <td>\$20,093</td> <td>\$118,213</td> <td>\$138,306</td> <td>\$121,278</td> </tr> <tr> <td>2016</td> <td>\$20,093</td> <td>\$115,738</td> <td>\$135,831</td> <td>\$118,784</td> </tr> </tbody> </table> <p style="text-align: center;"><a href="#">Disclaimer</a></p> <p style="text-align: center;"><b>Tax Estimator</b></p> <p style="text-align: center;">&gt; <a href="#">File for New Homestead Exemption Online</a></p>	Year	Land	Imprv	Total	Cap Val	2018	\$20,093	\$129,411	\$149,504	\$123,824	2017	\$20,093	\$118,213	\$138,306	\$121,278	2016	\$20,093	\$115,738	\$135,831	\$118,784
Year	Land	Imprv	Total	Cap Val																	
2018	\$20,093	\$129,411	\$149,504	\$123,824																	
2017	\$20,093	\$118,213	\$138,306	\$121,278																	
2016	\$20,093	\$115,738	\$135,831	\$118,784																	

<p><b>Sales Data</b></p> <table border="1"> <thead> <tr> <th>Sale Date</th> <th>Book</th> <th>Page</th> <th>Value</th> <th>Type</th> <th>Official Records (New Window)</th> </tr> </thead> <tbody> <tr> <td>01/20/2014</td> <td>7131</td> <td>1618</td> <td>\$100</td> <td>QC</td> <td><a href="#">View Instr</a></td> </tr> <tr> <td>01/20/2014</td> <td>7131</td> <td>1616</td> <td>\$100</td> <td>QC</td> <td><a href="#">View Instr</a></td> </tr> <tr> <td>02/2004</td> <td>5526</td> <td>231</td> <td>\$500</td> <td>QC</td> <td><a href="#">View Instr</a></td> </tr> </tbody> </table> <p>Official Records Inquiry courtesy of Pam Childers Escambia County Clerk of the Circuit Court and Comptroller</p>	Sale Date	Book	Page	Value	Type	Official Records (New Window)	01/20/2014	7131	1618	\$100	QC	<a href="#">View Instr</a>	01/20/2014	7131	1616	\$100	QC	<a href="#">View Instr</a>	02/2004	5526	231	\$500	QC	<a href="#">View Instr</a>	<p><b>2018 Certified Roll Exemptions</b> HOMESTEAD EXEMPTION</p> <p><b>Legal Description</b></p> <p>S 165 FT OF W 125 FT OF S 1/2 OF SE 1/4 OF NE 1/4 OF NW 1/4 OR 5526 P 231 OR 7131 P 1616 OR 7131 P 1618 PART OF LT 13...</p> <p><b>Extra Features</b> None</p>
Sale Date	Book	Page	Value	Type	Official Records (New Window)																				
01/20/2014	7131	1618	\$100	QC	<a href="#">View Instr</a>																				
01/20/2014	7131	1616	\$100	QC	<a href="#">View Instr</a>																				
02/2004	5526	231	\$500	QC	<a href="#">View Instr</a>																				

**Parcel Information**

**Section Map Id:** 10-1S-30-1

**Approx. Acreage:** 0.4700

**Zoned:** MDR

**Evacuation & Flood Information**  
[Open Report](#)

126.20    125    165    165    125

[Launch Interactive Map](#)

[View Florida Department of Environmental Protection\(DEP\) Data](#)

<b>Buildings</b>	
Address: 1591 REBECCA ST, Year Built: 2006, Effective Year: 2006	
<p><b>Structural Elements</b></p> <p><b>DECOR/MILLWORK-ABOVE AVERAGE</b></p> <p><b>DWELLING UNITS-1</b></p> <p><b>EXTERIOR WALL-BRICK-FACE/VENEER</b></p> <p><b>FLOOR COVER-TILE/STAIN CONC/BRICK</b></p> <p><b>FOUNDATION-SLAB ON GRADE</b></p>	

**HEAT/AIR-CENTRAL H/AC**  
**INTERIOR WALL-DRYWALL-DECORAT**  
**NO. PLUMBING FIXTURES-8**  
**NO. STORIES-1**  
**ROOF COVER-DIMEN/ARCH SHNG**  
**ROOF FRAMING-GABL/HIP HI PTC**  
**STORY HEIGHT-0**  
**STRUCTURAL FRAME-WOOD FRAME**

 Areas - 2449 Total SF  
**BASE AREA - 1615**  
**GARAGE FIN - 528**  
**OPEN PORCH FIN - 30**  
**PATIO - 276**

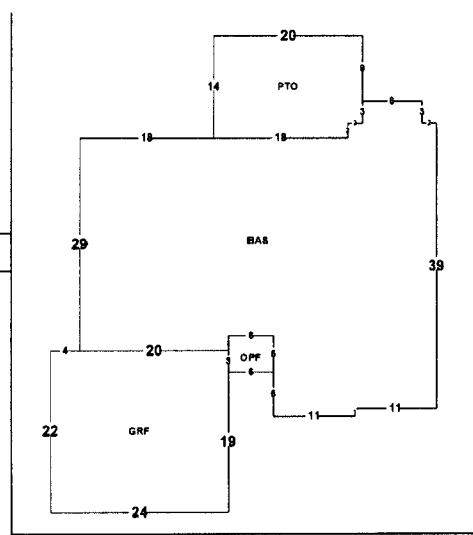

Images



10/16/12

The primary use of the assessment data is for the preparation of the current year tax roll. No responsibility or liability is assumed for inaccuracies or errors.

Last Updated:04/25/2019 (tc.28049)

## NOTICE OF APPLICATION FOR TAX DEED

NOTICE IS HEREBY GIVEN, That **CATALINA TAX CO LLC SERIES 17 US BANK** holder of **Tax Certificate No. 00459**, issued the **1st day of June, A.D., 2017** has filed same in my office and has made application for a tax deed to be issued thereon. Said certificate embraces the following described property in the County of Escambia, State of Florida, to wit:

**S 165 FT OF W 125 FT OF S 1/2 OF SE 1/4 OF NE 1/4 OF NW 1/4 OR 5526 P 231 OR 7131 P 1616 OR 7131 P 1618 PART OF LT 13 BLK 3 PLAT DB 89 PG 369**

**SECTION 10, TOWNSHIP 1 S, RANGE 30 W**

**TAX ACCOUNT NUMBER 020089020 (19-445)**

The assessment of the said property under the said certificate issued was in the name of

**JAMES D NIMS and AMBER NIMS**

Unless said certificate shall be redeemed according to law, the property described therein will be sold to the highest bidder at public auction at 9:00 A.M. on the **first Tuesday** in the month of September, which is the **3rd day of September 2019**.

Dated this 29th day of April 2019.

In accordance with the AMERICANS WITH DISABILITIES ACT, if you are a person with a disability who needs special accommodation in order to participate in this proceeding you are entitled to the provision of certain assistance. Please contact Emily Hogg not later than seven days prior to the proceeding at Escambia County Government Complex, 221 Palafox Place Ste 110, Pensacola FL 32502. Telephone: 850-595-3793.



PAM CHILDERS  
CLERK OF THE CIRCUIT COURT  
ESCAMBIA COUNTY, FLORIDA

By:  
Emily Hogg  
Deputy Clerk

**PAM CHILDERS**  
 CLERK OF THE CIRCUIT COURT  
 ARCHIVES AND RECORDS  
 CHILDSUPPORT  
 CIRCUIT CIVIL  
 CIRCUIT CRIMINAL  
 COUNTY CIVIL  
 COUNTY CRIMINAL  
 DOMESTIC RELATIONS  
 FAMILY LAW  
 JURY ASSEMBLY  
 JUVENILE  
 MENTAL HEALTH  
 MIS  
 OPERATIONAL SERVICES  
 PROBATE  
 TRAFFIC



**BRANCH OFFICES**  
**ARCHIVES AND RECORDS**  
**JUVENILE DIVISION**  
**CENTURY**

CLERK TO THE BOARD OF  
 COUNTY COMMISSIONERS  
 OFFICIAL RECORDS  
 COUNTY TREASURY  
 AUDITOR

**COUNTY OF ESCAMBIA**  
**OFFICE OF THE**  
**CLERK OF THE CIRCUIT COURT**

**PAM CHILDERS, CLERK OF THE CIRCUIT COURT**  
**Tax Certificate Redeemed From Sale**  
**Account: 020089020 Certificate Number: 000459 of 2017**

**Payor: AMBER NIMS 1591 REBECCA ST PENSACOLA, FL 32534 Date 05/16/2019**

Clerk's Check #	267125	Clerk's Total	\$502.03
Tax Collector Check #	1	Tax Collector's Total	\$5,178.57
		Postage	\$0.00
		Researcher Copies	\$0.00
		Recording	\$10.00
		Prep Fee	\$7.00
		Total Received	<del>\$5,757.60</del>

\$5043.89

\$5060.89

**PAM CHILDERS**  
 Clerk of the Circuit Court

Received By: \_\_\_\_\_  
 Deputy Clerk

Escambia County Government Complex • 221 Palafox Place Ste 110 • PENSACOLA, FLORIDA 32502  
 (850) 595-3793 • FAX (850) 595-4827 • <http://www.clerk.co.escambia.fl.us>

**PAM CHILDERS**  
 CLERK OF THE CIRCUIT COURT  
 ARCHIVES AND RECORDS  
 CHILDSUPPORT  
 CIRCUIT CIVIL  
 CIRCUIT CRIMINAL  
 COUNTY CIVIL  
 COUNTY CRIMINAL  
 DOMESTIC RELATIONS  
 FAMILY LAW  
 JURY ASSEMBLY  
 JUVENILE  
 MENTAL HEALTH  
 MIS  
 OPERATIONAL SERVICES  
 PROBATE  
 TRAFFIC



**BRANCH OFFICES**  
**ARCHIVES AND RECORDS**  
**JUVENILE DIVISION**  
**CENTURY**

CLERK TO THE BOARD OF  
 COUNTY COMMISSIONERS  
 OFFICIAL RECORDS  
 COUNTY TREASURY  
 AUDITOR

**COUNTY OF ESCAMBIA**  
**OFFICE OF THE**  
**CLERK OF THE CIRCUIT COURT**

**Case # 2017 TD 000459**

**Redeemed Date 05/16/2019**

**Name AMBER NIMS 1591 REBECCA ST PENSACOLA, FL 32534**

Clerk's Total = TAXDEED	\$502.03
Due Tax Collector = TAXDEED	\$5,178.57 <b>5043.89</b>
Postage = TD2	\$60.00
ResearcherCopies = TD6	\$0.00
Release TDA Notice (Recording) = RECORD2	\$10.00
Release TDA Notice (Prep Fee) = TD4	\$7.00

• For Office Use Only

Date	Docket	Desc	Amount Owed	Amount Due	Payee Name
------	--------	------	-------------	------------	------------

**FINANCIAL SUMMARY**

No Information Available - See Dockets



**PAM CHILDERS**  
**CLERK OF THE CIRCUIT COURT**  
**ESCAMBIA COUNTY, FLORIDA**

**Tax Deed - Redemption Calculator**  
**Account: 020089020 Certificate Number: 000459 of 2017**

Redemption  Yes  No     
 Application Date      
 Interest Rate

	Final Redemption Payment ESTIMATED	Redemption Overpayment ACTUAL
	Auction Date <input type="text" value="09/03/2019"/>	Redemption Date <input type="text" value="05/16/2019"/>
Months	5	1
Tax Collector	<input type="text" value="\$4,811.46"/>	<input type="text" value="\$4,811.46"/>
Tax Collector Interest	\$360.86	\$72.17
Tax Collector Fee	<input type="text" value="\$6.25"/>	<input type="text" value="\$6.25"/>
Total Tax Collector	\$5,178.57	<input type="text" value="\$4,889.88"/> <i>TC</i>
Record TDA Notice	<input type="text" value="\$17.00"/>	<input type="text" value="\$17.00"/>
Clerk Fee	<input type="text" value="\$130.00"/>	<input type="text" value="\$130.00"/>
Sheriff Fee	<input type="text" value="\$120.00"/>	<input type="text" value="\$120.00"/>
Legal Advertisement	<input type="text" value="\$200.00"/>	<input type="text" value="\$200.00"/>
App. Fee Interest	\$35.03	\$7.01
Total Clerk	\$502.03	<input type="text" value="\$474.01"/> <i>CH</i>
Release TDA Notice (Recording)	<input type="text" value="\$10.00"/>	<input type="text" value="\$10.00"/>
Release TDA Notice (Prep Fee)	<input type="text" value="\$7.00"/>	<input type="text" value="\$7.00"/>
Postage	<input type="text" value="\$60.00"/>	<input type="text" value="\$0.00"/>
Researcher Copies	<input type="text" value="\$40.00"/>	<input type="text" value="\$0.00"/>
Total Redemption Amount	\$5,797.60	\$5,380.89
	Repayment Overpayment Refund Amount	\$416.71
Book/Page	<input type="text"/>	<input type="text"/>

Notes



## RELEASE OF NOTICE OF APPLICATION FOR TAX DEED

Pursuant to § 197.502(5)(c), Florida Statutes, the Escambia County Clerk of Court fully releases the Notice of Tax Deed Application recorded at Official Records Book 8086, Page 574, of Escambia County, for the tax certificate, tax deed, and property described below:

Tax Certificate No. Certificate No. 00459, issued the 1st day of June, A.D., 2017

TAX ACCOUNT NUMBER: 020089020 (19-445)

DESCRIPTION OF PROPERTY:

S 165 FT OF W 125 FT OF S 1/2 OF SE 1/4 OF NE 1/4 OF NW 1/4 OR 5526 P 231 OR 7131 P 1616  
OR 7131 P 1618 PART OF LT 13 BLK 3 PLAT DB 89 PG 369

SECTION 10, TOWNSHIP 1 S, RANGE 30 W

NAME IN WHICH ASSESSED: JAMES D NIMS and AMBER NIMS

Dated this 16th day of May 2019.



PAM CHILDERS  
CLERK OF THE CIRCUIT COURT  
ESCAMBIA COUNTY, FLORIDA

By:  
Emily Hogg  
Deputy Clerk

**Southern Guaranty Title Company**

4400 Bayou Boulevard, Suite 13B

Pensacola, Florida 32503

Telephone: 850-478-8121

Facsimile: 850-476-1437

19-445

Redeemed

**PROPERTY INFORMATION REPORT**

File No.: 15199

June 4, 2019

Escambia County Tax Collector  
P.O. Box 1312  
Pensacola, Florida 32591

Pursuant to your request, the Company has caused a search to be made of the Public Records of Escambia County, Florida, solely as revealed by records maintained from 06-04-1999, through 06-04-2019, and said search reveals the following:

1. THE GRANTEE(S) OF THE LAST DEED(S) OF RECORD IS:

James Dustion Nims and Amber Nims, husband and wife

2. The land covered by this Report is:

LEGAL DESCRIPTION IS ATTACHED HERETO AND MADE A PART HEREOF

3. The following unsatisfied mortgages, liens and judgments affecting the land covered by this Report appear of record:

SEE CONTINUATION PAGE ATTACHED HERETO AND MADE A PART HEREOF

4. Taxes:

SEE CONTINUATION PAGE ATTACHED HERETO AND MADE A PART HEREOF

This report is not title insurance. Pursuant to s. 627.7843, Florida Statutes, the maximum liability of the issuer of this property information report for errors or omissions in this property information report is limited to the amount paid for this property information report, and is further limited to the person(s) expressly identified by name in the property information report as the recipients(s) of the property information report.

THIS REPORT SHALL NOT BE USED FOR THE ISSUANCE OF TITLE INSURANCE.

Southern Guaranty Title Company

By: 

June 4, 2019

**PROPERTY INFORMATION REPORT  
LEGAL DESCRIPTION**

File No.: 15199

June 4, 2019

**101S301101132003 - Full Legal Description**

S 165 FT OF W 125 FT OF S 1/2 OF SE 1/4 OF NE 1/4 OF NW 1/4 OR 5526 P 231 OR 7131 P 1616 OR 7131 P 1618  
PART OF LT 13 BLK 3 PLAT DB 89 PG 369

**PROPERTY INFORMATION REPORT  
CONTINUATION PAGE**

File No.: 15199

June 4, 2019

UNSATISFIED MORTGAGES, LIENS AND JUDGMENTS AFFECTING THE LAND COVERED BY THIS REPORT THAT APPEAR OF RECORD:

1. All Taxes Paid. The assessed value is \$149,504.00. Tax ID 02-0089-020.

PLEASE NOTE THE FOLLOWING:

- A. Subject to current year taxes.
- B. Taxes and assessments due now or in subsequent years.
- C. Subject to Easements, Restrictions and Covenants of record.
- D. Encroachments, overlaps, boundary line disputes, and any other matters which would be disclosed by an accurate survey and inspection of the premises.
- E. Oil, gas and mineral or any other subsurface rights of any kind or nature.

# SOUTHERN GUARANTY TITLE COMPANY

4400 BAYOU BLVD., SUITE 13-B, CORDOVA SQUARE

PENSACOLA, FLORIDA 32503

TEL. (850) 478-8121 FAX (850) 476-1437

Email: rcsgt@aol.com

Scott Lunsford  
Escambia County Tax Collector  
P.O. Box 1312  
Pensacola, FL 32591

CERTIFICATION: TITLE SEARCH FOR TDA

TAX DEED SALE DATE: 9-3-2019

TAX ACCOUNT NO.: 02-0089-020

CERTIFICATE NO.: 2017-459

In compliance with Section 197.256, Florida Statutes, the following is a list of names and addresses of those persons, firms and/or agencies having legal interest in or claim against the above described property. The above referenced tax sale certificate is being submitted as proper notification of tax deed sale.

YES NO

Notify City of Pensacola, P.O. Box 12910, 32521

Notify Escambia County, 190 Governmental Center, 32502

Homestead for 2019 tax year.

James Dustin Nims  
Amber Nims  
1591 Rebecca St.  
Pensacola, FL 32534

Certified and delivered to Escambia County Tax Collector,  
this 4th day of June, 2019.

SOUTHERN GUARANTY TITLE COMPANY

  
by: Richard S. Combs, President

NOTE: The above listed addresses are based upon current information available, but said addresses are not guaranteed to be true or correct.

Prepared By:  
Stephen R. Moorhead, Esquire  
McDonald Fleming Moorhead  
25 West Government Street  
Pensacola, FL 32502

**QUIT CLAIM DEED**

STATE OF FLORIDA  
COUNTY OF ESCAMBIA

KNOW ALL MEN BY THESE PRESENTS, that JAMES DUSTIN NIMS and AMBER NIMS, husband and wife, whose mailing address is 1591 Rebecca Street, Pensacola, FL 32534, for and in consideration of Ten Dollars (\$10.00) and other good and valuable consideration, the receipt of which is hereby acknowledged, does remise, release and quit claim unto JAMES DUSTIN NIMS and AMBER NIMS, husband and wife, whose mailing address is 1591 Rebecca Street, Pensacola, FL 32534, their heirs, administrators, successors and assigns, forever, the following described real property in the County of Escambia, State of Florida, to-wit:

The South 165 feet of the West 125 feet of the South Half of the Southeast Quarter of the Northeast Quarter of the Northwest Quarter, being Lot 13, Block 3 (Plat Deed Book 89, at Page 369 of the public records of Escambia County, Florida) in Section 10, Township 1 South, Range 30 West, containing 5 acres more or less.

Together with all and singular the tenements, hereditaments, and appurtenances thereto belonging or in anywise appertaining, free from all exceptions and right of homestead.

IN WITNESS WHEREOF, the undersigned executed this instrument on this 20 day of ~~January~~ ~~December, 2013~~ 2014

WITNESSES:

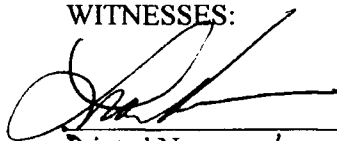
  
Printed Name Lisa Brennan

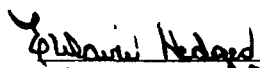
  
Printed Name Elaine Hedges

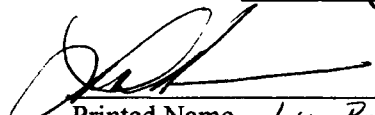
  
Printed Name Lisa Brennan

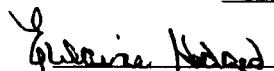
  
Printed Name Elaine Hedges

  
JAMES DUSTIN NIMS

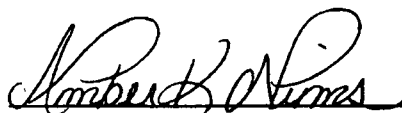
  
AMBER NIMS

STATE OF FLORIDA  
COUNTY OF ESCAMBIA

~~2013~~ <sup>2014</sup> The foregoing instrument was acknowledged before me this 20 day of ~~December~~ <sup>January</sup>,  
by James Dustin Nims and Amber Nims, husband and wife.

Dianne S. Gainey  
NOTARY PUBLIC  
Print Name: Dianne S. Gainey

Personally Known  
 OR  
 Produced Identification  
Type of Identification Produced \_\_\_\_\_

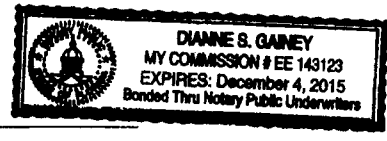

Prepared By:  
Stephen R. Moorhead, Esquire  
McDonald Fleming Moorhead  
25 West Government Street  
Pensacola, FL 32502

**QUIT CLAIM DEED**

STATE OF FLORIDA  
COUNTY OF ESCAMBIA

KNOW ALL MEN BY THESE PRESENTS, that RANDY ALAN NIMS and SHERRY A. NIMS, husband and wife, whose mailing address is 9211 Cove Ave., Pensacola, FL 32534, for and in consideration of Ten Dollars (\$10.00) and other good and valuable consideration, the receipt of which is hereby acknowledged, does remise, release and quit claim unto JAMES DUSTIN NIMS and AMBER NIMS, husband and wife, whose mailing address is 1591 Rebecca Street, Pensacola, FL 32534, their heirs, administrators, successors and assigns, forever, the following described real property in the County of Escambia, State of Florida, to-wit:

The South 165 feet of the West 125 feet of the South Half of the Southeast Quarter of the Northeast Quarter of the Northwest Quarter, being Lot 13, Block 3 (Plat Deed Book 89, at Page 369 of the public records of Escambia County, Florida) in Section 10, Township 1 South, Range 30 West, containing 5 acres more or less.

Together with all and singular the tenements, hereditaments, and appurtenances thereto belonging or in anywise appertaining, free from all exceptions and right of homestead.

~~January~~ IN WITNESS WHEREOF, the undersigned executed this instrument on this 20 day of ~~December, 2013.~~ 2014

WITNESSES:

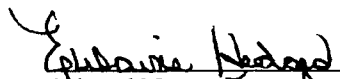
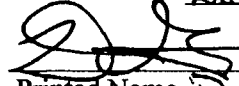
  
Printed Name Eulaine Hedger  
  
Printed Name David A. Bee

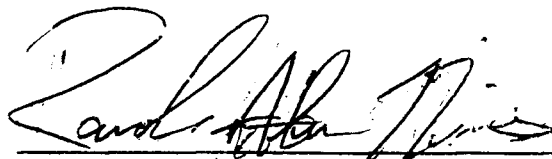
  
RANDY ALAN NIMS

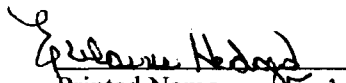
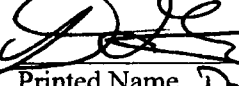
  
Printed Name Eulaine Hedger  
  
Printed Name David A. Bee

  
SHERRY A. NIMS



STATE OF FLORIDA  
COUNTY OF ESCAMBIA

~~2013~~ <sup>2014</sup> The foregoing instrument was acknowledged before me this 20 day of ~~December~~ <sup>January</sup>,  
2013, by Randy Alan Nims and Sherry A. Nims, husband and wife.

Dianne S. Gainey  
NOTARY PUBLIC  
Print Name: Dianne S. Gainey

Personally Known  
OR  
 Produced Identification  
Type of Identification Produced \_\_\_\_\_

