

# Tax Collector's Certification

CTY-513

**Tax Deed Application Number**

1700650

**Date of Tax Deed Application**

Aug 04, 2017

This is to certify that **ABRTL LLC AND AM CERT LLC PART CITIBANK, N.A., AS COLLATERAL**, holder of **Tax Sale Certificate Number 2015 / 1207**, Issued the 1st Day of June, 2015 and which encumbers the following described property in the county of Escambia County, State of Florida, to wit: **03-0491-125**

**Cert Holder:**

**ABRTL LLC AND AM CERT LLC PART CITIBANK, N.A., AS COLLATERAL  
4747 EXECUTIVE DRIVE SUITE 510 SAN DIEGO, CA 92121**

**Property Owner:**

**MACK ROBERT & JANNIE E  
1808 LEPLEY RD  
PENSACOLA, FL 32534  
BEG AT SW COR OF LT 70 ELY ALG S LI OF SD LT 120 FT NLY AT  
RT ANG 15 FT FOR POB CONT SAME COURSE 158 Full legal  
attached.**

has surrendered same in my office and made written application for tax deed in accordance with Florida Statutes. I certify that the following tax certificates, interest, ownership and encumbrance report fee, and Tax Collector's fees have been paid, or if the certificate is held by the County, all appropriate fees have been deposited.

Certificates owned by applicant and filed in connection with this application:

Certificate Year/Number	Account Number	Sale Date	Face Amount of Certificate	Interest	Total
2015/1207	03-0491-125	06/01/2015	485.56	24.28	509.84

Certificates redeemed by applicant or included (County) in connection with this tax deed application:

Certificate Year/Number	Account Number	Sale Date	Face Amount of Certificate	Tax Collector's Fee	Interest	Total
2017/1040	03-0491-125	06/01/2017	569.09	6.25	28.45	603.79
2016/1067	03-0491-125	06/01/2016	544.89	6.25	27.24	578.38

**Amounts Certified by Tax Collector (Lines 1-7):**

**Total Amount Paid**

1. Total of all Certificates in Applicant's Possession and Cost of the Certificates Redeemed by Applicant	1,692.01
2. Total of Delinquent Taxes Paid by Tax Deed Applicant	0.00
3. Total of Current Taxes Paid by Tax Deed Applicant	0.00
4. Ownership and Encumbrance Report Fee	200.00
5. Tax Deed Application Fee	175.00
6. Total Interest Accrued by Tax Collector Pursuant to Section 197.542, F.S.	
7. Total (Lines 1 - 6)	2,067.01

**Amounts Certified by Clerk of Court (Lines 8-15):**

**Total Amount Paid**

8. Clerk of Court Statutory Fee for Processing Tax Deed	
9. Clerk of Court Certified Mail Charge	
10. Clerk of Court Advertising Charge	
11. Clerk of Court Recording Fee for Certificate of Notice	
12. Sheriff's Fee	
13. Interest Computed by Clerk of Court Pursuant to Section 197.542, F.S.	
14. Total (Lines 8 - 13)	
15. One-half Assessed Value of Homestead Property, if Applicable per F.S.	36,580.50
16. Other Outstanding Certificates and Delinquent Taxes Not Included in this Application,	
17. Statutory (Opening) Bid; Total of Lines 7, 14, 15 (if applicable) and 16 (if	
18. Redemption Fee	6.25
19. Total Amount to Redeem	

Done this the 9th day of August, 2017 Scott Lunsford, Tax Collector of Escambia County

Date of Sale: 3/5/18

By

\*This certification must be surrendered to the Clerk of the Circuit Court no later than ten (10) days after this date.  
03-0491-125 2015

BEG AT SW COR OF LT 70 ELY ALG S LI OF SD LT 120 FT NLY AT RT ANG 15 FT FOR POB CONT SAME COURSE 158 5/10 FT WL Y 90  
DEG 120 FT SLY 90 DEG 158 5/10 FT ELY 90 DEG 120 F T TO POB S/D PLAT DB 128 P 541 OR 980 P 314 OR 2338 P 658

# APPLICATION FOR TAX DEED

Section 197.502, Florida Statutes

512  
R. 12/16

Application Number: 1700650

To: Tax Collector of ESCAMBIA COUNTY, Florida

I,  
ABRTL LLC AND AM CERT LLC PART CITIBANK, N.A., AS COLLATERAL  
4747 EXECUTIVE DRIVE SUITE 510  
SAN DIEGO, CA 92121,

hold the listed tax certificate and hereby surrender the same to the Tax Collector and make tax deed application thereon:

Account Number	Certificate No.	Date	Legal Description
03-0491-125	2015/1207	06-01-2015	BEG AT SW COR OF LT 70 ELY ALG S LI OF SD LT 120 FT NLY AT RT ANG 15 FT FOR POB CONT SAME COURSE 158 5/10 FT WL Y 90 DEG 120 FT SLY 90 DEG 158 5/10 FT ELY 90 DEG 120 F T TO POB S/D PLAT DB 128 P 541 OR 980 P 314 OR 2338 P 658

I agree to:

- pay any current taxes, if due and
- redeem all outstanding tax certificates plus interest not in my possession, and
- pay all delinquent and omitted taxes, plus interest covering the property.
- pay all Tax Collector's fees, ownership and encumbrance report costs, Clerk of the Court costs, charges and fees, and Sheriff's costs, if applicable.

Attached is the tax sale certificate on which this application is based and all other certificates of the same legal description which are in my possession.

Electronic signature on file  
ABRTL LLC AND AM CERT LLC PART CITIBANK, N.A.,  
AS COLLATERAL  
4747 EXECUTIVE DRIVE SUITE 510  
SAN DIEGO, CA 92121

08-04-2017  
Application Date

\_\_\_\_\_  
Applicant's signature



# Chris Jones Escambia County Property Appraiser

- Real Estate Search
- Tangible Property Search
- Sale List
- Amendment 1/Portability Calculations

[Back](#)

←  Navigate Mode  Account  Reference →

[Printer Friendly Version](#)

General Information	Assessments																				
<b>Reference:</b> 231S301201003070 <b>Account:</b> 030491125 <b>Owners:</b> MACK ROBERT & JANNIE E <b>Mail:</b> 1808 LEPLEY RD PENSACOLA, FL 32534 <b>Situs:</b> 1808 LEPLEY RD 32534 <b>Use Code:</b> SINGLE FAMILY RESID <b>Taxing Authority:</b> COUNTY MSTU <b>Schools (Elem/Int/High):</b> LINCOLN PARK/WOODHAM/PINE FOREST <b>Tax Inquiry:</b> <a href="#">Open Tax Inquiry Window</a> Tax Inquiry link courtesy of Scott Lunsford Escambia County Tax Collector	<table border="1" style="width: 100%; border-collapse: collapse;"> <thead> <tr> <th>Year</th> <th>Land</th> <th>Imprv</th> <th>Total</th> <th>Cap Val</th> </tr> </thead> <tbody> <tr> <td>2017</td> <td>\$12,113</td> <td>\$69,952</td> <td>\$82,065</td> <td>\$74,697</td> </tr> <tr> <td>2016</td> <td>\$12,113</td> <td>\$69,929</td> <td>\$82,042</td> <td>\$73,161</td> </tr> <tr> <td>2015</td> <td>\$12,113</td> <td>\$69,804</td> <td>\$81,917</td> <td>\$72,653</td> </tr> </tbody> </table> <p style="text-align: center;"><a href="#">Disclaimer</a></p> <p style="text-align: center;"><a href="#">Amendment 1/Portability Calculations</a></p> <p style="text-align: center;">★ <a href="#">File for New Homestead Exemption Online</a></p>	Year	Land	Imprv	Total	Cap Val	2017	\$12,113	\$69,952	\$82,065	\$74,697	2016	\$12,113	\$69,929	\$82,042	\$73,161	2015	\$12,113	\$69,804	\$81,917	\$72,653
Year	Land	Imprv	Total	Cap Val																	
2017	\$12,113	\$69,952	\$82,065	\$74,697																	
2016	\$12,113	\$69,929	\$82,042	\$73,161																	
2015	\$12,113	\$69,804	\$81,917	\$72,653																	

Sales Data	2017 Certified Roll Exemptions																								
<table border="1" style="width: 100%; border-collapse: collapse;"> <thead> <tr> <th>Sale Date</th> <th>Book</th> <th>Page</th> <th>Value</th> <th>Type</th> <th>Official Records (New Window)</th> </tr> </thead> <tbody> <tr> <td>01/1987</td> <td>2338</td> <td>658</td> <td>\$100</td> <td>WD</td> <td><a href="#">View Instr</a></td> </tr> <tr> <td>01/1976</td> <td>980</td> <td>314</td> <td>\$1,000</td> <td>WD</td> <td><a href="#">View Instr</a></td> </tr> <tr> <td>01/1973</td> <td>754</td> <td>73</td> <td>\$1,000</td> <td>WD</td> <td><a href="#">View Instr</a></td> </tr> </tbody> </table> <p>Official Records Inquiry courtesy of Pam Childers Escambia County Clerk of the Circuit Court and Comptroller</p>	Sale Date	Book	Page	Value	Type	Official Records (New Window)	01/1987	2338	658	\$100	WD	<a href="#">View Instr</a>	01/1976	980	314	\$1,000	WD	<a href="#">View Instr</a>	01/1973	754	73	\$1,000	WD	<a href="#">View Instr</a>	HOMESTEAD EXEMPTION, SENIOR EXEMPTION  <b>Legal Description</b> BEG AT SW COR OF LT 70 ELY ALG S LI OF SD LT 120 FT NLY AT RT ANG 15 FT FOR POB CONT SAME COURSE 158 5/10 FT WL Y...  <b>Extra Features</b> None
Sale Date	Book	Page	Value	Type	Official Records (New Window)																				
01/1987	2338	658	\$100	WD	<a href="#">View Instr</a>																				
01/1976	980	314	\$1,000	WD	<a href="#">View Instr</a>																				
01/1973	754	73	\$1,000	WD	<a href="#">View Instr</a>																				

**Parcel Information**

**Section Map Id:**  
23-1S-30-1

**Approx. Acreage:**  
0.4418

**Zoned:**   
HDMU

**Evacuation & Flood Information**  
[Open Report](#)

[Launch Interactive Map](#)

7

78.5

120

80

00

[View Florida Department of Environmental Protection \(DEP\) Data](#)

Buildings
Address: 1808 LEPLEY RD, Year Built: 1970, Effective Year: 1970 <b>Structural Elements</b> DECOR/MILLWORK-BELOW AVERAGE DWELLING UNITS-1 EXTERIOR WALL-BRICK-FACE/VENEER FLOOR COVER-CARPET

**FOUNDATION-SLAB ON GRADE**  
**HEAT/AIR-CENTRAL H/AC**  
**INTERIOR WALL-DRYWALL-PLASTER**  
**INTERIOR WALL-PANEL-PLYWOOD**  
**NO. PLUMBING FIXTURES-3**  
**NO. STORIES-1**  
**ROOF COVER-COMPOSITION SHG**  
**ROOF FRAMING-GABLE**  
**STORY HEIGHT-0**  
**STRUCTURAL FRAME-WOOD FRAME**

 Areas - 2996 Total SF

**BASE AREA - 2050**  
**BASE SEMI FIN - 360**  
**GARAGE UNFIN - 336**  
**OPEN PORCH FIN - 110**  
**UTILITY UNF - 140**

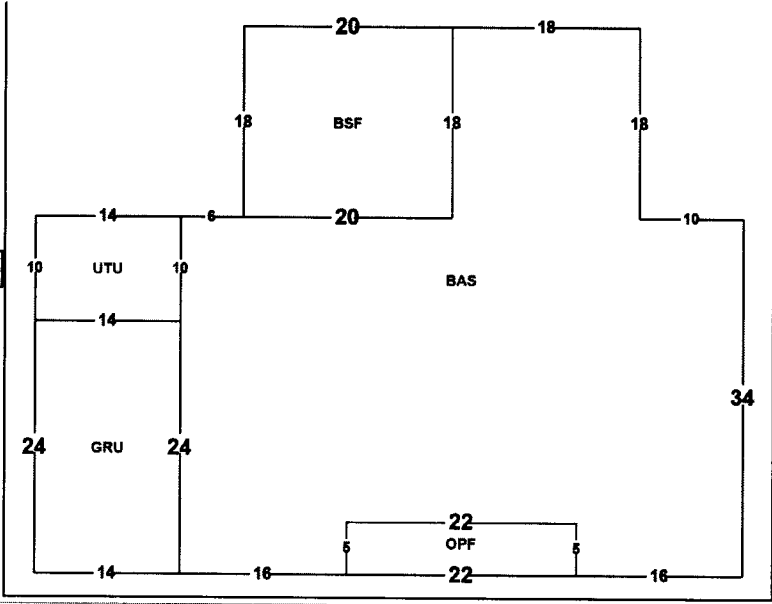

Images



7/17/14

The primary use of the assessment data is for the preparation of the current year tax roll. No responsibility or liability is assumed for inaccuracies or errors.

Last Updated:09/14/2017 (tc.935)

**PAM CHILDERS**  
 CLERK OF THE CIRCUIT COURT  
 ARCHIVES AND RECORDS  
 CHILDSUPPORT  
 CIRCUIT CIVIL  
 CIRCUIT CRIMINAL  
 COUNTY CIVIL  
 COUNTY CRIMINAL  
 DOMESTIC RELATIONS  
 FAMILY LAW  
 JURY ASSEMBLY  
 JUVENILE  
 MENTAL HEALTH  
 MIS  
 OPERATIONAL SERVICES  
 PROBATE  
 TRAFFIC



**COUNTY OF ESCAMBIA  
 OFFICE OF THE  
 CLERK OF THE CIRCUIT COURT**

File #: 18-085

**BRANCH OFFICES  
 ARCHIVES AND RECORDS  
 JUVENILE DIVISION  
 CENTURY**

CLERK TO THE BOARD OF  
 COUNTY COMMISSIONERS  
 OFFICIAL RECORDS  
 COUNTY TREASURY  
 AUDITOR

**PAM CHILDERS, CLERK OF THE CIRCUIT COURT  
 Tax Certificate Redeemed From Sale  
 Account: 032945000 Certificate Number: 001572 of 2015**

**Payor: CHRISTOPHER A CAREY 1421 GAMARRA RD PENSACOLA, FL 32503      Date 10/26/2017**

Clerk's Check #	5503248903	Clerk's Total	\$497.25
Tax Collector Check #	1	Tax Collector's Total	\$2,092.01
		Postage	\$60.00
		Researcher Copies	\$0.00
		Total Received	<del>\$2,649.26</del> \$2,129.01

**PAM CHILDERS  
 Clerk of the Circuit Court**

Received By: Whitney Coppage  
 Deputy Clerk

**Escambia County Government Complex • 221 Palafox Place Ste 110 • PENSACOLA, FLORIDA 32502  
 (850) 595-3793 • FAX (850) 595-4827 • <http://www.clerk.co.escambia.fl.us>**

**PAM CHILDERS**  
 CLERK OF THE CIRCUIT COURT  
 ARCHIVES AND RECORDS  
 CHILDSUPPORT  
 CIRCUIT CIVIL  
 CIRCUIT CRIMINAL  
 COUNTY CIVIL  
 COUNTY CRIMINAL  
 DOMESTIC RELATIONS  
 FAMILY LAW  
 JURY ASSEMBLY  
 JUVENILE  
 MENTAL HEALTH  
 MIS  
 OPERATIONAL SERVICES  
 PROBATE  
 TRAFFIC



**COUNTY OF ESCAMBIA  
 OFFICE OF THE  
 CLERK OF THE CIRCUIT COURT**

**BRANCH OFFICES  
 ARCHIVES AND RECORDS  
 JUVENILE DIVISION  
 CENTURY**

CLERK TO THE BOARD OF  
 COUNTY COMMISSIONERS  
 OFFICIAL RECORDS  
 COUNTY TREASURY  
 AUDITOR

**Case # 2015 TD 001572**

**Redeemed Date 10/26/2017**

**Name CHRISTOPHER A CAREY 1421 GAMARRA RD PENSACOLA, FL 32503**

Clerk's Total = TAXDEED	\$497.25
Due Tax Collector = TAXDEED	\$2,092.01
Postage = TD2	\$60.00
ResearcherCopies = TD6	\$0.00

• For Office Use Only

<b>Date</b>	<b>Docket</b>	<b>Desc</b>	<b>Amount Owed</b>	<b>Amount Due</b>	<b>Payee Name</b>
-------------	---------------	-------------	--------------------	-------------------	-------------------

**FINANCIAL SUMMARY**

No Information Available - See Dockets



# Pam Childers

Clerk of the Circuit Court and Comptroller, Escambia County

Clerk of Courts • County Comptroller • Clerk of the Board of County Commissioners • Recorder •

October 31, 2017

MED ALI LLC AND MALLY LLC PART CITIBANK NA AS COLLATERAL  
4747 EXECUTIVE DRIVE SUITE 510  
SAN DIEGO CA 92121

Dear Certificate Holder:

The records of this office show that an application for a tax deed had been made on the property represented by the numbered certificate listed below. The property redeemed prior to sale; therefore your application fees are now refundable.

TAX CERT	APP FEES	INTEREST	TOTAL
2015 TD 001572	\$450.00	\$20.25	\$470.25

**TOTAL \$470.25**

Very truly yours,

PAM CHILDERS  
Clerk of Circuit Court

By:

Emily Hogg  
Tax Deed Division



**Southern Guaranty Title Company**

4400 Bayou Boulevard, Suite 13B

Pensacola, Florida 32503

Telephone: 850-478-8121

Facsimile: 850-476-1437

18-146  
Redlined

**OWNERSHIP AND ENCUMBRANCE REPORT**

File No.: 14131

January 2, 2018

Escambia County Tax Collector  
P.O. Box 1312  
Pensacola, Florida 32591

Pursuant to your request, the Company has caused a search to be made of the Public Records of Escambia County, Florida, solely as revealed by records maintained from 01-02-1998, through 01-02-2018, and said search reveals the following:

1. THE GRANTEE(S) OF THE LAST DEED(S) OF RECORD IS:

Robert Mack and Jannie E. Mack, husband and wife

2. The land covered by this Report is:

LEGAL DESCRIPTION IS ATTACHED HERETO AND MADE A PART HEREOF

3. The following unsatisfied mortgages, liens and judgments affecting the land covered by this Report appear of record:

SEE CONTINUATION PAGE ATTACHED HERETO AND MADE A PART HEREOF

4. Taxes:

SEE CONTINUATION PAGE ATTACHED HERETO AND MADE A PART HEREOF

The foregoing report is prepared and furnished for information only, is not intended to constitute or imply any opinion, warranty, guaranty, insurance, or similar assurance as to the status of title, and no determination has been made of the authenticity of any instrument described or referred to herein. The name search for the purposes of determining applicable judgments and liens is limited to the apparent record owner(s) shown herein. No attempt has been made to determine whether the land is subject to liens or assessments which are not shown as existing liens by the public records. The Company's liability hereunder shall not exceed the cost of this Report, or \$1,000.00 whichever is less.

THIS REPORT SHALL NOT BE USED FOR THE ISSUANCE OF TITLE INSURANCE.

Southern Guaranty Title Company

By: 

January 2, 2018

**OWNERSHIP AND ENCUMBRANCE REPORT  
LEGAL DESCRIPTION**

File No.: 14131

January 2, 2018

**231S301201003070 - Full Legal Description**

BEG AT SW COR OF LT 70 ELY ALG S LI OF SD LT 120 FT NLY AT RT ANG 15 FT FOR POB CONT SAME  
COURSE 158 5/10 FT WL Y 90 DEG 120 FT SLY 90 DEG 158 5/10 FT ELY 90 DEG 120 F T TO POB S/D PLAT DB  
128 P 541 OR 980 P 314 OR 2338 P 658

**OWNERSHIP AND ENCUMBRANCE REPORT  
CONTINUATION PAGE**

File No.: 14131

January 2, 2018

UNSATISFIED MORTGAGES, LIENS AND JUDGMENTS AFFECTING THE LAND COVERED BY THIS REPORT THAT APPEAR OF RECORD:

1. Code Enforcement Lien filed by Escambia County recorded in O.R.. Book 6142, page 1854.
2. MSBU Lien filed by Escambia County recorded in O.R. Book 4313, page 1433, and O.R. Book 4436, page 1740.
3. Civil Lien filed by State of Florida recorded in O.R. Book 7202, page 989.
4. Taxes for the year 2017 due. Delinquent taxes redeemed.. The assessed value is \$82,065.00. Tax ID 03-0491-125.

PLEASE NOTE THE FOLLOWING:

- A. Subject to current year taxes.
- B. Taxes and assessments due now or in subsequent years.
- C. Subject to Easements, Restrictions and Covenants of record.
- D. Encroachments, overlaps, boundary line disputes, and any other matters which would be disclosed by an accurate survey and inspection of the premises.
- E. Oil, gas and mineral or any other subsurface rights of any kind or nature.

# SOUTHERN GUARANTY TITLE COMPANY

4400 BAYOU BLVD., SUITE 13-B, CORDOVA SQUARE

PENSACOLA, FLORIDA 32503

TEL. (850) 478-8121 FAX (850) 476-1437

Email: rcsqt@aol.com

Scott Lunsford  
Escambia County Tax Collector  
P.O. Box 1312  
Pensacola, FL 32591

CERTIFICATION: TITLE SEARCH FOR TDA

TAX DEED SALE DATE: 3-5-2018

TAX ACCOUNT NO.: 03-0491-125

CERTIFICATE NO.: 2015-1207

In compliance with Section 197.256, Florida Statutes, the following is a list of names and addresses of those persons, firms and/or agencies having legal interest in or claim against the above described property. The above referenced tax sale certificate is being submitted as proper notification of tax deed sale.

YES NO

      x   Notify City of Pensacola, P.O. Box 12910, 32521

  x       Notify Escambia County, 190 Governmental Center, 32502

  x       Homestead for 2017 tax year.

Robert and Jannie E. Mack  
1808 Lepley Rd.  
Pensacola, FL 32534

Escambia County Code Enforcement  
3363 West Park Place  
Pensacola, FL 32505

Certified and delivered to Escambia County Tax Collector,  
this 5th day of January, 2018.

SOUTHERN GUARANTY TITLE COMPANY

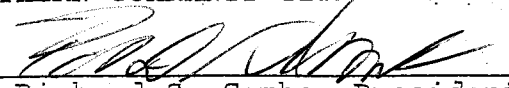
  
by: Richard S. Combs, President

NOTE: The above listed addresses are based upon current information available, but said addresses are not guaranteed to be true or correct.

5.00  
50  
State of Florida  
Escambia County

# WARRANTY DEED

Know All Men by These Presents: That BEN L. DAVIS, JR. AND BETTY JEAN DAVIS, HUSBAND AND WIFE

for and in consideration of \$10.00 AND OTHER VALUABLE CONSIDERATION DOLLARS

the receipt whereof is hereby acknowledged, do bargain, sell, convey and grant unto ROBERT MACK AND JANNIE E. MACK, HUSBAND AND WIFE  
(1808 LEVLEY ROAD, PENSACOLA, FL 32514)

THEIR heirs, executors, administrators and assigns, forever, the following described real property, situate, lying and being in the County of ESCAMBIA State of FLORIDA to-wit:

COMMENCING AT THE SOUTHWEST CORNER OF LOT 70, SECTION 23, TOWNSHIP 1 SOUTH, RANGE 30 WEST, ESCAMBIA COUNTY, FLORIDA; THENCE EASTERLY ALONG THE SOUTH LINE OF SAID LOT 70 A DISTANCE OF 120 FEET; THENCE NORTHERLY AT RIGHT ANGLES A DISTANCE OF 15 FEET TO THE POINT OF BEGINNING; THENCE CONTINUE SAME COURSE A DISTANCE OF 158.5 FEET; THENCE WESTERLY AT 90 DEGREES A DISTANCE OF 120 FEET; THENCE SOUTHERLY AT 90 DEGREES A DISTANCE OF 158.5 FEET; THENCE EASTERLY AT 90 DEGREES A DISTANCE OF 120 FEET TO THE POINT OF BEGINNING.

THIS IS A CORRECTIVE DEED TO CORRECT THE CONVEYANCE RECORDED ON PAGE 73 IN THE OFFICIAL RECORDS OF ESCAMBIA COUNTY, FLORIDA.

514378  
FILED AND RECORDED IN THE PUBLIC RECORDS OF ESCAMBIA COUNTY, FLA. ON  
JAN 20 12 05 PM '87  
IN BOOK & PAGE NOT RECORDED BY JOE A. FLOWERS, COMPTROLLER ESCAMBIA COUNTY, FLA.

Together with all and singular the tenements, hereditaments and appurtenances thereto belonging or in anywise appertaining, free from all exemptions and right of homestead.

And THEY covenant that THEY ARE well seized of an indefeasible estate in fee simple in the said property, and have a good right to convey the same; that it is free of lien or encumbrance, and that THEIR heirs, executors and administrators, the said grantee S, THEIR heirs, executors, administrators and assigns, in the quiet and peaceable possession and enjoyment thereof, against all persons lawfully claiming the same, shall and will forever warrant and defend.

IN WITNESS WHEREOF, WE have hereunto set OUR hand S and seal S this 14 day of JANUARY A. D. 1987.

Signed, sealed and delivered in the presence of  
[Signature] (SEAL)  
BEN L. DAVIS, JR. (SEAL)  
[Signature] (SEAL)  
BETTY JEAN DAVIS (SEAL)  
D.S. PD. \$ 50  
DATE 1-20-87

State of Florida  
Escambia County  
JOE A. FLOWERS, COMPTROLLER  
BY: [Signature] D.C.  
CERT. REG. #59-2043328-27-01

Before the subscriber personally appeared BEN L. DAVIS, JR., and BETTY JEAN DAVIS his wife, known to me, and known to me to be the individual S described by said name S in and who executed the foregoing instrument and acknowledged that THEY executed the same for the uses and purposes therein set forth.

Given under my hand and official seal this 14<sup>th</sup> day of January 1987

This instrument was prepared by:  
S. L. Miller  
P. O. Box 126  
Address  
Pensacola, FL 32591

My commission expires  
Notary Public, State of Florida  
My Commission Expires  
BONDED BY THE STATE OF FLORIDA

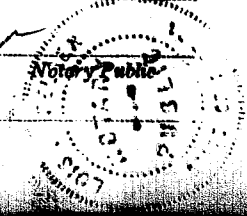

**THE OFFICE OF ENVIRONMENTAL ENFORCEMENT  
SPECIAL MAGISTRATE  
IN AND FOR THE  
COUNTY OF ESCAMBIA, STATE OF FLORIDA**

ESCAMBIA COUNTY, FLORIDA

Vs.

Case No.: 07-02-1206  
Location: 1808 Lepley Road  
PR# 231S30-1201-003-070

Robert & Jannie E. Mack  
1808 Lepley Road  
Pensacola, FL 32534

**ORDER**

This CAUSE having come before the Office of Environmental Enforcement Special Magistrate on the Petition of the Environmental Enforcement Officer for alleged violation of the ordinances of the County of Escambia, State of Florida, and the Special Magistrate having considered the evidence before him in the form of testimony by the Enforcement Officer and the respondent or representative, Robert Mack as well as evidence submitted and after consideration of the appropriate sections of the Escambia County Code of Ordinances, the Special Magistrate finds that a violation of the Code of Ordinances 42-196(A)  
42-196(S), 42-196(C), 42-196(D)  
has occurred and continues.

THEREFORE, The Special Magistrate being otherwise fully advised in the premises; it is hereby ORDERED that: Robert + Jannice Mack shall have until 6/8, 2007 to correct the violation and to bring the violation into compliance. Corrective action shall include: \_\_\_\_\_

Abate all conditions in the Notice of violation  
to include Repair vehicles, Removal  
+ debris

If you fail to fully correct the violation within the time required, you will be assessed a fine of \$ 150 per day, commencing 6/9 /, 2007. This daily fine shall continue until this violation is abated and the violation brought into compliance or until as otherwise provided by law. Immediately upon your full correction of this violation, you should contact the Escambia County Environmental Enforcement Office in writing to request that they immediately inspect the property to make an official determination of whether the violation has been abated and brought into compliance.

If the violation is not abated within the specified time period, then the County may elect to abate the violation for you and the reasonable cost of such will be assessed against you and will constitute a lien on the property.

Costs in the amount of \$1,100.00 are hereby awarded in favor of Escambia County as the prevailing party against Robert + Jannice Mack

This fine shall be forwarded to the Board of County Commissioners. Under the authority of 162.09(1), F.S. and Sec. 30-34(d) of the Code of Ordinances, the Board of County Commissioners may make all reasonable repairs necessary to bring the property into compliance if the violator does not correct the violation by a specified date.

The costs of such repairs shall be certified to the Special Magistrate and may be added to any fines imposed pursuant to this order.

All monies owing hereunder shall constitute a lien on all your real and personal property including any property involved herein, which lien can be enforced by foreclosure and as provided by law.

You have the right to appeal orders of the Special Magistrate to the Circuit Court of Escambia County. If you wish to appeal, you must give notice of such in writing to both the Environmental Enforcement Division at 6708 Plantation Road Pensacola, Florida 32504 and the Escambia County Circuit Court Clerk at the M.C. Blanchard Judicial Building, 190 Governmental Center, Pensacola, Florida 32501, no later than 30 days from the date of the Order. Failure to timely file a written Notice of Appeal will waive your rights to appeal.

Jurisdiction is retained to enter such further orders as may be appropriate and necessary.

DONE AND ORDERED at Escambia County, Florida on the 27<sup>th</sup> day of May, 2007.

  
\_\_\_\_\_  
Robert O Beasley  
Special Magistrate  
Office of Environmental Enforcement

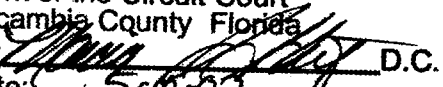
Certified to be a true copy of  
the original on file in this office  
Witness my hand and official seal  
ERNIE LEE MAGAHA  
Clerk of the Circuit Court  
Escambia County Florida  
By:  D.C.  
Date: 5-10-07

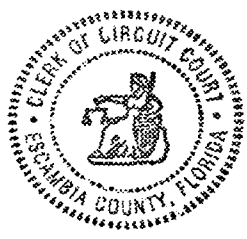



County, FL

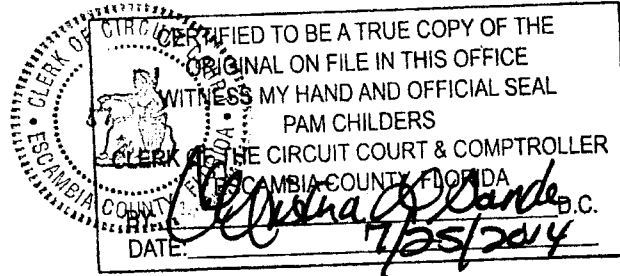

IN THE COUNTY COURT IN AND FOR ESCAMBIA COUNTY, FLORIDA

STATE OF FLORIDA,

Plaintiff,

vs.

CASE NO: 2006-MM-022731-A

DIVISION: ONE

ROBERT MACK

Defendant.

CIVIL LIEN

THIS CAUSE came before the Court for plea on August 8, 2007 . Upon the evidence presented, the Court assessed \$445 cost of supervision arrears plus \$50 hearing fee.

Therefore, the Court determines that \$495 is due to Department of Community Corrections. Accordingly, pursuant to the provisions of §938.30, Florida Statutes, it is,

ORDERED AND ADJUDGED that the above-named Defendant shall pay cost of supervision arrears to the Department of Community Corrections, in the amount of \$495 which shall accrue interest at the rate of ELEVEN percent (11%) per annum.

ORDERED FURTHER that nothing in this Civil Lien will bar any subsequent civil remedy or recovery, but the amount paid under this order shall be a set-off against any subsequent independent civil recovery. Any default in payment of the amount due hereunder may be collected by any means authorized by law for the enforcement of a civil judgment, for which let execution issue.

14th DONE AND ORDERED in Chambers, at Pensacola, Escambia County, Florida, the day of August 2007

*Joyce H. Williams*  
JOYCE H. WILLIAMS, COUNTY JUDGE

cc: ✓ Attorney for Defendant  
✓ Assistant State Attorney, Division ONE  
✓ GWEN WILLIAMS COMMUNITY CORRECTIONS

20

✓ ROBERT MACK  
DOB:10-14-86  
1808 LEPLY RD.  
PENSACOLA FL. 32534

E #:46731

FILED & RECORDED  
2007 AUG 15 P 3:05

Case: 2006 MM 022731 A



00088147805

Dkt: MM642 Pg#: