

19-485

# Tax Collector's Certification

CTY-513

**Tax Deed Application Number**  
1900154

**Date of Tax Deed Application**  
Apr 17, 2019

This is to certify that **CATALINA TAX CO LLC SERIES 17 US BANK % CATALINA TAX -SER 17**, holder of **Tax Sale Certificate Number 2017 / 5125**, Issued the 1st Day of June, 2017 and which encumbers the following described property in the county of Escambia County, State of Florida, to wit: **09-4625-838**

**Cert Holder:**  
**CATALINA TAX CO LLC SERIES 17 US BANK % CATALINA TAX -SER 17**  
**PO BOX 645040**  
**CINCINNATI, OH 45264-5040**

**Property Owner:**  
**HALL EVA JANE**  
**3422 BOWKER ROAD**  
**PENSACOLA, FL 32506**

LT 8 BLK E WOODRIDGE MANOR UNIT 3 PB 13 P 76 OR 2758 P  
987 LESS MINERAL RIGHTS

has surrendered same in my office and made written application for tax deed in accordance with Florida Statutes. I certify that the following tax certificates, interest, ownership and encumbrance report fee, and Tax Collector's fees have been paid, or if the certificate is held by the County, all appropriate fees have been deposited.

Certificates owned by applicant and filed in connection with this application:

Certificate Year/Number	Account Number	Sale Date	Face Amount of Certificate	Interest	Total
2017/5125	09-4625-838	06/01/2017	1,683.28	84.16	1,767.44

Certificates redeemed by applicant or included (County) in connection with this tax deed application:

Certificate Year/Number	Account Number	Sale Date	Face Amount of Certificate	Tax Collector's Fee	Interest	Total
/						

**Amounts Certified by Tax Collector (Lines 1-7):**

**Total Amount Paid**

1. Total of all Certificates in Applicant's Possession and Cost of the Certificates Redeemed by Applicant	1,767.44
2. Total of Delinquent Taxes Paid by Tax Deed Applicant	0.00
3. Total of Current Taxes Paid by Tax Deed Applicant	0.00
4. Property Information Report Fee	200.00
5. Tax Deed Application Fee	175.00
6. Total Interest Accrued by Tax Collector Pursuant to Section 197.542, F.S.	
7. Total (Lines 1 - 6)	2,142.44

**Amounts Certified by Clerk of Court (Lines 8-15):**

**Total Amount Paid**

8. Clerk of Court Statutory Fee for Processing Tax Deed	
9. Clerk of Court Certified Mail Charge	
10. Clerk of Court Advertising Charge	
11. Clerk of Court Recording Fee for Certificate of Notice	
12. Sheriff's Fee	
13. Interest Computed by Clerk of Court Pursuant to Section 197.542, F.S.	
14. Total (Lines 8 - 13)	
15. One-half Assessed Value of Homestead Property, if Applicable per F.S.	
16. Other Outstanding Certificates and Delinquent Taxes Not Included in this Application,	
17. Statutory (Opening) Bid; Total of Lines 7, 14, 15 (if applicable) and 16 (if	
18. Redemption Fee	6.25
19. Total Amount to Redeem	

Done this the 24th day of April, 2019 Scott Lunsford, Tax Collector of Escambia County

Date of Sale: 10-7-19 By 

\*This certification must be surrendered to the Clerk of the Circuit Court no later than ten (10) days after this date.  
09-4625-838 2017

# APPLICATION FOR TAX DEED

Section 197.502, Florida Statutes

512  
R. 12/16

Application Number: 1900154

To: Tax Collector of ESCAMBIA COUNTY, Florida

I,  
CATALINA TAX CO LLC SERIES 17 US BANK % CATALINA TAX -SER 17  
PO BOX 645040  
CINCINNATI, OH 45264-5040,

hold the listed tax certificate and hereby surrender the same to the Tax Collector and make tax deed application thereon:

Account Number	Certificate No.	Date	Legal Description
09-4625-838	2017/5125	06-01-2017	LT 8 BLK E WOODRIDGE MANOR UNIT 3 PB 13 P 76 OR 2758 P 987 LESS MINERAL RIGHTS

I agree to:

- pay any current taxes, if due and
- redeem all outstanding tax certificates plus interest not in my possession, and
- pay all delinquent and omitted taxes, plus interest covering the property.
- pay all Tax Collector's fees, property information report costs, Clerk of the Court costs, charges and fees, and Sheriff's costs, if applicable.

Attached is the tax sale certificate on which this application is based and all other certificates of the same legal description which are in my possession.

Electronic signature on file  
CATALINA TAX CO LLC SERIES 17 US BANK %  
CATALINA TAX -SER 17  
PO BOX 645040  
CINCINNATI, OH 45264-5040

04-17-2019  
Application Date

\_\_\_\_\_  
Applicant's signature



Chris Jones  
Escambia County Property Appraiser

Real Estate Search    Tangible Property Search    Sale List

[Back](#)

◀ Navigate Mode  Account  Reference ▶

[Printer Friendly Version](#)

**General Information**  
**Reference:** 252S313100008005  
**Account:** 094625838  
**Owners:** HALL EVA JANE  
**Mail:** 3422 BOWKER ROAD  
 PENSACOLA, FL 32506  
**Situs:** 10933 OAK VALLEY DR 32506  
**Use Code:** SINGLE FAMILY RESID   
**Taxing Authority:** COUNTY MSTU  
**Tax Inquiry:** [Open Tax Inquiry Window](#)  
 Tax Inquiry link courtesy of Scott Lunsford  
 Escambia County Tax Collector

**Assessments**

Year	Land	Imprv	Total	Cap Val
2018	\$17,000	\$89,147	\$106,147	\$106,147
2017	\$17,000	\$81,751	\$98,751	\$98,751
2016	\$17,000	\$77,793	\$94,793	\$94,793

[Disclaimer](#)

**Tax Estimator**

> [File for New Homestead Exemption Online](#)

**Sales Data**

Sale Date	Book	Page	Value	Type	Official Records (New Window)
11/22/2016	7626	1732	\$100	OT	<a href="#">View Instr</a>
09/09/2016	7591	944	\$72,000	WD	<a href="#">View Instr</a>
09/1989	2758	987	\$64,600	WD	<a href="#">View Instr</a>
07/1989	2730	838	\$11,300	WD	<a href="#">View Instr</a>

Official Records Inquiry courtesy of Pam Childers  
 Escambia County Clerk of the Circuit Court and  
 Comptroller

**2018 Certified Roll Exemptions**  
 None

**Legal Description**  
 LT 8 BLK E WOODRIDGE MANOR UNIT 3 PB 13 P 76 OR 7591  
 P 944 LESS MINERAL RIGHTS

**Extra Features**  
 None

**Parcel Information** [Launch Interactive Map](#)

**Section Map Id:**  
 25-2S-31-2

**Approx. Acreage:**  
 0.2591

**Zoned:**   
 MDR

**Evacuation & Flood Information**  
[Open Report](#)

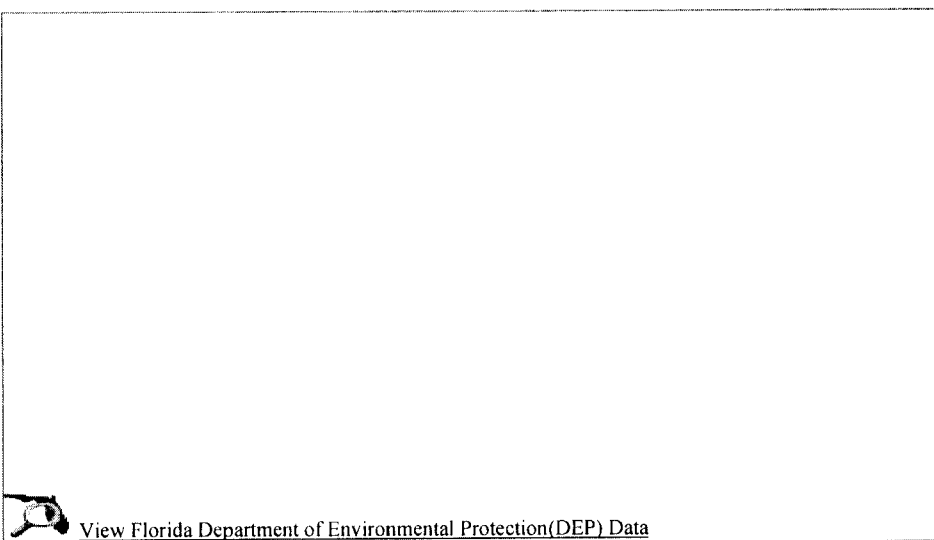

[View Florida Department of Environmental Protection\(DEP\) Data](#)

**Buildings**  
 Address: 10933 OAK VALLEY DR, Year Built: 1989, Effective Year: 1989

**Structural Elements**  
 DECOR/MILLWORK-AVERAGE  
 DWELLING UNITS-1  
 EXTERIOR WALL-BRICK-FACE/VENEER  
 FLOOR COVER-CARPET  
 FOUNDATION-SLAB ON GRADE  
 HEAT/AIR-CENTRAL H/AC

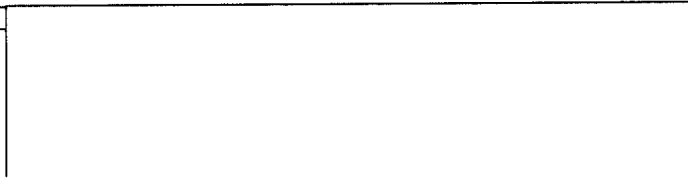

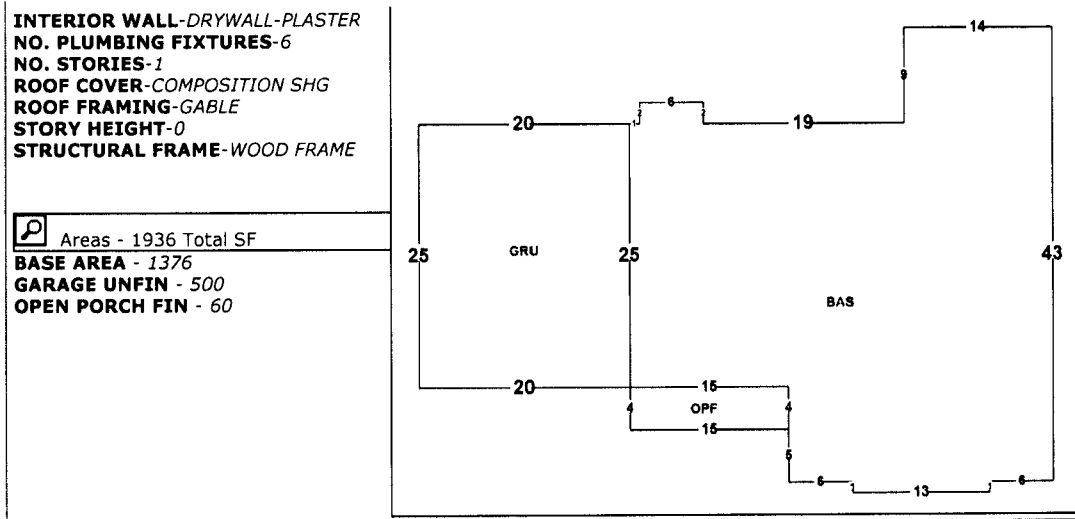

Images



4/11/18

The primary use of the assessment data is for the preparation of the current year tax roll. No responsibility or liability is assumed for inaccuracies or errors.

Last Updated:04/25/2019 (tc.33913)

## NOTICE OF APPLICATION FOR TAX DEED

NOTICE IS HEREBY GIVEN, That **CATALINA TAX CO LLC SERIES 17 US BANK** holder of **Tax Certificate No. 05125**, issued the **1st day of June, A.D., 2017** has filed same in my office and has made application for a tax deed to be issued thereon. Said certificate embraces the following described property in the County of Escambia, State of Florida, to wit:

**LT 8 BLK E WOODRIDGE MANOR UNIT 3 PB 13 P 76 OR 2758 P 987 LESS MINERAL RIGHTS**

**SECTION 25, TOWNSHIP 2 S, RANGE 31 W**

**TAX ACCOUNT NUMBER 094625838 (19-485)**

The assessment of the said property under the said certificate issued was in the name of

**EVA JANE HALL**

Unless said certificate shall be redeemed according to law, the property described therein will be sold to the highest bidder at public auction at 9:00 A.M. on the **first Monday** in the month of October, which is the **7th day of October 2019**.

Dated this 3rd day of May 2019.

In accordance with the AMERICANS WITH DISABILITIES ACT, if you are a person with a disability who needs special accommodation in order to participate in this proceeding you are entitled to the provision of certain assistance. Please contact Emily Hogg not later than seven days prior to the proceeding at Escambia County Government Complex, 221 Palafox Place Ste 110, Pensacola FL 32502. Telephone: 850-595-3793.



PAM CHILDERS  
CLERK OF THE CIRCUIT COURT  
ESCAMBIA COUNTY, FLORIDA

By:  
Emily Hogg  
Deputy Clerk

## RELEASE OF NOTICE OF APPLICATION FOR TAX DEED

Pursuant to § 197.502(5)(c), Florida Statutes, the Escambia County Clerk of Court fully releases the Notice of Tax Deed Application recorded at Official Records Book 8089, Page 490, of Escambia County, for the tax certificate, tax deed, and property described below:

Tax Certificate No. Certificate No. 05125, issued the 1st day of June, A.D., 2017

TAX ACCOUNT NUMBER: **094625838 (19-485)**

DESCRIPTION OF PROPERTY:

**LT 8 BLK E WOODRIDGE MANOR UNIT 3 PB 13 P 76 OR 2758 P 987 LESS MINERAL RIGHTS**

**SECTION 25, TOWNSHIP 2 S, RANGE 31 W**

NAME IN WHICH ASSESSED: EVA JANE HALL

Dated this 8th day of May 2019.



PAM CHILDERS  
CLERK OF THE CIRCUIT COURT  
ESCAMBIA COUNTY, FLORIDA

By:  
Emily Hogg  
Deputy Clerk

19-485

**PAM CHILDERS**  
 CLERK OF THE CIRCUIT COURT  
 ARCHIVES AND RECORDS  
 CHILDSUPPORT  
 CIRCUIT CIVIL  
 CIRCUIT CRIMINAL  
 COUNTY CIVIL  
 COUNTY CRIMINAL  
 DOMESTIC RELATIONS  
 FAMILY LAW  
 JURY ASSEMBLY  
 JUVENILE  
 MENTAL HEALTH  
 MIS  
 OPERATIONAL SERVICES  
 PROBATE  
 TRAFFIC



**BRANCH OFFICES**  
**ARCHIVES AND RECORDS**  
**JUVENILE DIVISION**  
**CENTURY**

CLERK TO THE BOARD OF  
 COUNTY COMMISSIONERS  
 OFFICIAL RECORDS  
 COUNTY TREASURY  
 AUDITOR

**COUNTY OF ESCAMBIA**  
**OFFICE OF THE**  
**CLERK OF THE CIRCUIT COURT**

**PAM CHILDERS, CLERK OF THE CIRCUIT COURT**  
**Tax Certificate Redeemed From Sale**  
**Account: 094625838 Certificate Number: 005125 of 2017**

**Payor: EVA J HALL 3422 BOWKER ROAD PENSACOLA, FL 32506      Date 05/08/2019**

Clerk's Check #	1	Clerk's Total	\$509.03
Tax Collector Check #	1	Tax Collector's Total	\$2,341.51
		Postage	\$60.00
		Researcher Copies	\$0.00
		Recording	\$10.00
		Prep Fee	\$7.00
		Total Received	<del>\$2,927.54</del>
			<b>\$ 2,351.84</b>

**PAM CHILDERS**  
 Clerk of the Circuit Court

Received By: NCoppage  
 Deputy Clerk

**PAM CHILDERS**  
 CLERK OF THE CIRCUIT COURT  
 ARCHIVES AND RECORDS  
 CHILDSUPPORT  
 CIRCUIT CIVIL  
 CIRCUIT CRIMINAL  
 COUNTY CIVIL  
 COUNTY CRIMINAL  
 DOMESTIC RELATIONS  
 FAMILY LAW  
 JURY ASSEMBLY  
 JUVENILE  
 MENTAL HEALTH  
 MIS  
 OPERATIONAL SERVICES  
 PROBATE  
 TRAFFIC



**COUNTY OF ESCAMBIA  
 OFFICE OF THE  
 CLERK OF THE CIRCUIT COURT**

**BRANCH OFFICES  
 ARCHIVES AND RECORDS  
 JUVENILE DIVISION  
 CENTURY**

CLERK TO THE BOARD OF  
 COUNTY COMMISSIONERS  
 OFFICIAL RECORDS  
 COUNTY TREASURY  
 AUDITOR

**Case # 2017 TD 005125**

**Redeemed Date 05/08/2019**

**Name EVA J HALL 3422 BOWKER ROAD PENSACOLA, FL 32506**

Clerk's Total = TAXDEED	\$509.03	7 \$2,334.84
Due Tax Collector = TAXDEED	\$2,341.51	
Postage = TD2	\$60.00	
ResearcherCopies = TD6	\$0.00	
Release TDA Notice (Recording) = RECORD2	\$10.00	
Release TDA Notice (Prep Fee) = TD4	\$7.00	

• For Office Use Only

Date	Docket	Desc	Amount Owed	Amount Due	Payee Name
------	--------	------	-------------	------------	------------

**FINANCIAL SUMMARY**

No Information Available - See Dockets





### PAM CHILDERS CLERK OF THE CIRCUIT COURT ESCAMBIA COUNTY, FLORIDA

#### Tax Deed - Redemption Calculator

Account: 094625838 Certificate Number: 005125 of 2017

Redemption	Yes <input type="checkbox"/>	Application Date	04/17/2019	Interest Rate	18%
		Final Redemption Payment ESTIMATED		Redemption Overpayment ACTUAL	
		Auction Date	10/07/2019	Redemption Date	05/08/2019
Months	6			1	
Tax Collector	\$2,142.44			\$2,142.44	
Tax Collector Interest	\$192.82			\$32.14	
Tax Collector Fee	\$6.25			\$6.25	
Total Tax Collector	\$2,341.51			\$2,180.83	T.C.
Record TDA Notice	\$17.00			\$17.00	
Clerk Fee	\$130.00			\$130.00	
Sheriff Fee	\$120.00			\$120.00	
Legal Advertisement	\$200.00			\$200.00	
App. Fee Interest	\$42.03			\$7.01	
Total Clerk	\$509.03			\$474.01	C.H.
Release TDA Notice (Recording)	\$10.00			\$10.00	
Release TDA Notice (Prep Fee)	\$7.00			\$7.00	
Postage	\$60.00			\$0.00	
Researcher Copies	\$40.00			\$0.00	
Total Redemption Amount	\$2,967.54			\$2,671.84	
		Repayment Overpayment Refund Amount		\$295.70	
Book/Page	8089			490	

Notes



# Pam Childers

Clerk of the Circuit Court and Comptroller, Escambia County

Clerk of Courts • County Comptroller • Clerk of the Board of County Commissioners • Recorder •

May 15, 2019

CATALINA TAX CO LLC SERIES 17 US BANK  
PO BOX 645040  
CINCINNATI OH 45264

Dear Certificate Holder:

The records of this office show that an application for a tax deed had been made on the property represented by the numbered certificate listed below. The property redeemed prior to sale; therefore your application fees are now refundable.

TAX CERT	APP FEES	INTEREST	TOTAL
2017 TD 006551	\$467.00	\$7.01	\$474.01
2017 TD 001599	\$467.00	\$7.01	\$474.01
2017 TD 005318	\$467.00	\$7.01	\$474.01
2017 TD 005125	\$467.00	\$7.01	\$474.01
2017 TD 001690	\$467.00	\$7.01	\$474.01

**TOTAL \$2,370.05**

Very truly yours,

PAM CHILDERS  
Clerk of Circuit Court

By:

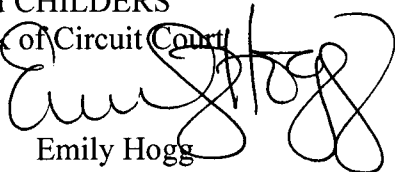
  
Emily Hogg  
Tax Deed Division

**Southern Guaranty Title Company**

4400 Bayou Boulevard, Suite 13B

Pensacola, Florida 32503

Telephone: 850-478-8121

Facsimile: 850-476-1437

19-485

Redeemed

**PROPERTY INFORMATION REPORT**

File No.: 15245

July 11, 2019

Escambia County Tax Collector

P.O. Box 1312

Pensacola, Florida 32591

Pursuant to your request, the Company has caused a search to be made of the Public Records of Escambia County, Florida, solely as revealed by records maintained from 07-11-1999, through 07-11-2019, and said search reveals the following:

1. THE GRANTEE(S) OF THE LAST DEED(S) OF RECORD IS:

Eva Jane Hall

2. The land covered by this Report is:

LEGAL DESCRIPTION IS ATTACHED HERETO AND MADE A PART HEREOF

3. The following unsatisfied mortgages, liens and judgments affecting the land covered by this Report appear of record:

SEE CONTINUATION PAGE ATTACHED HERETO AND MADE A PART HEREOF

4. Taxes:

SEE CONTINUATION PAGE ATTACHED HERETO AND MADE A PART HEREOF

This report is not title insurance. Pursuant to s. 627.7843, Florida Statutes, the maximum liability of the issuer of this property information report for errors or omissions in this property information report is limited to the amount paid for this property information report, and is further limited to the person(s) expressly identified by name in the property information report as the recipients(s) of the property information report.

THIS REPORT SHALL NOT BE USED FOR THE ISSUANCE OF TITLE INSURANCE.

Southern Guaranty Title Company

By: 

July 11, 2019

**PROPERTY INFORMATION REPORT  
LEGAL DESCRIPTION**

File No.: 15245

July 11, 2019

**Lot 8, Block E, Woodridge Manor Unit #3, as per plat thereof, recorded in Plat Book 13, Page 76, of the Public Records of Escambia County, Florida**

**PROPERTY INFORMATION REPORT  
CONTINUATION PAGE**

File No.: 15245

July 11, 2019

UNSATISFIED MORTGAGES, LIENS AND JUDGMENTS AFFECTING THE LAND COVERED BY THIS REPORT THAT APPEAR OF RECORD:

1. All Taxes Paid. The assessed value is \$106,147.00. Tax ID 09-4625-838.

PLEASE NOTE THE FOLLOWING:

- A. Subject to current year taxes.
- B. Taxes and assessments due now or in subsequent years.
- C. Subject to Easements, Restrictions and Covenants of record.
- D. Encroachments, overlaps, boundary line disputes, and any other matters which would be disclosed by an accurate survey and inspection of the premises.
- E. Oil, gas and mineral or any other subsurface rights of any kind or nature.

# SOUTHERN GUARANTY TITLE COMPANY

4400 BAYOU BLVD., SUITE 13-B, CORDOVA SQUARE

PENSACOLA, FLORIDA 32503

TEL. (850) 478-8121 FAX (850) 476-1437

Email: rcsgr@aol.com

Escambia County Tax Collector  
P.O. Box 1312  
Pensacola, FL

CERTIFICATION: TITLE SEARCH FOR TDA

TAX DEED SALE DATE: 10-7-2019

TAX ACCOUNT NO.: 09-4625-838

CERTIFICATE NO.: ~~1049~~ 2017-5125

In compliance with Section 197.256, Florida Statutes, the following is a list of names and addresses of those persons, firms and/or agencies having legal interest in or claim against the above described property. The above referenced tax sale certificate is being submitted as proper notification of tax deed sale.

YES NO

Notify City of Pensacola, P.O. Box 12910, 32521

Notify Escambia County, 190 Governmental Center, 32502

Homestead for \_\_\_\_\_ tax year.

Eva Jane Hall  
3422 Bowker Rd.  
Pensacola, FL 32506  
and  
10933 Oak Valley Dr.  
Pensacola, FL 32506

Certified and delivered to Escambia County Tax Collector,  
this 12th day of July, 2019.

SOUTHERN GUARANTY TITLE COMPANY

  
by: Richard S. Combs, President

NOTE: The above listed addresses are based upon current information available, but said addresses are not guaranteed to be true or correct.

Prepared by and return to:  
Deedra L. Lamy  
Emerald Coast Title, Inc.  
811 N. Spring Street  
Pensacola, FL 32501  
850-434-3223  
File Number: 16-12052

[Space Above This Line For Recording Data]

## Warranty Deed

This Warranty Deed made this 8<sup>th</sup> day of September, 2016 between Sandra L. Buster, an unremarried widow whose post office address is 108 Jordan Street, Reidsville, GA 30453, grantor, and Eva Jane Hall, a single woman whose post office address is 6395 N. Blue Angel Parkway, Bellview, FL 32526, grantee:

(Whenever used herein the terms "grantor" and "grantee" include all the parties to this instrument and the heirs, legal representatives, and assigns of individuals, and the successors and assigns of corporations, trusts and trustees)

Witnesseth, that said grantor, for and in consideration of the sum of TEN AND NO/100 DOLLARS (\$10.00) and other good and valuable considerations to said grantor in hand paid by said grantee, the receipt whereof is hereby acknowledged, has granted, bargained, and sold to the said grantee, and grantee's heirs and assigns forever, the following described land, situate, lying and being in Escambia County, Florida to-wit:

Lot 8, Block E, Woodridge Manor Unit #3, being a portion of Section 25, Township 2 South, Range 31 West, according to the Plat thereof, recorded in Plat Book 13, Page(s) 76, of the Public Records of Escambia County, Florida.

Parcel Identification Number: 252S313100008005

Together with all the tenements, hereditaments and appurtenances thereto belonging or in anywise appertaining.

To Have and to Hold, the same in fee simple forever.

And the grantor hereby covenants with said grantee that the grantor is lawfully seized of said land in fee simple; that the grantor has good right and lawful authority to sell and convey said land; that the grantor hereby fully warrants the title to said land and will defend the same against the lawful claims of all persons whomsoever; and that said land is free of all encumbrances, except taxes accruing subsequent to December 31, 2015.

In Witness Whereof, grantor has hereunto set grantor's hand and seal the day and year first above written.

Signed, sealed and delivered in our presence:

① Glenda Smith  
Witness Name: Glenda Smith  
② Lillie Durence  
Witness Name: Lillie Durence

Sandra L. Buster (seal)  
Sandra L. Buster

State of Georgia  
County of TATNAW

The foregoing instrument was acknowledged before me this 8<sup>th</sup> day of September, 2016 by Sandra L. Buster, who  is personally known or  has produced a driver's license as identification.

[Notary Seal]

Notary Public

Printed Name: Deedra L. Lamy

My Commission Expires 6/08/18

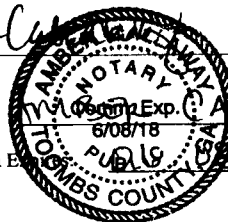

## Abutting Roadway Maintenance

STATE OF FLORIDA  
COUNTY OF ESCAMBIA

**ATTENTION:** Pursuant to Escambia County Ordinances Chapter 1-29.2, Article V, sellers of residential lots are required to disclose to Buyers whether abutting roadways will be maintained by Escambia County, and if not what person or entity will be responsible for maintenance. The disclosure must additionally provide that Escambia County does not accept roads for maintenance that have not been built or improved to meet county standards. Escambia County Code of Ordinances Chapter 1-29.2, Article V, requires this disclosure be attached along with other attachments to the deed or other method of conveyance required to be made part of the public records of Escambia County, Florida. Note: Acceptance for filing by County employees of this disclosure shall in no way be construed as an acknowledgement by the County of the veracity of any disclosure statement.

Name of Roadway: 10933 Oak Valley Drive, Pensacola, FL 32506

THE COUNTY (x) HAS ACCEPTED ( ) HAS NOT ACCEPTED THE ABUTTING ROADWAY FOR MAINTENANCE.

If not, it will be the responsibility of \_\_\_\_\_ to maintain, repair and improve the road.

This form completed by:  
Michael D. Tidwell, Attorney  
811 North Spring Street  
Pensacola, Florida 32501

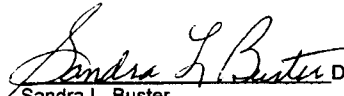
 Date 9/8/16  
Sandra L. Buster

STATE OF Georgia  
COUNTY OF TATNALL

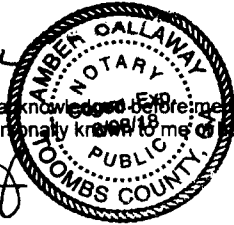

The foregoing instrument was acknowledged before me this 8<sup>th</sup> day of September, 2016 by Sandra L. Buster, an unmarried widow who are personally known to me or have produced a driver's license as identification.

  
Notary Public

\_\_\_\_\_  
Date 9/9/16  
Eva Jane Hall

STATE OF FLORIDA  
COUNTY OF ESCAMBIA

The foregoing instrument was acknowledged before me this \_\_\_\_\_ day of September, 2016 by Eva Jane Hall, a single woman who are personally known to me or has produced a driver's license as identification.

\_\_\_\_\_  
Notary Public