

17-439

Tax Collector's Certification

CTY-513

Tax Deed Application Number
1700252

Date of Tax Deed Application
Apr 25, 2017

This is to certify that **IDE**
IDE TECHNOLOGIES INC, holder of **Tax Sale Certificate Number 2015 / 9796**, Issued the 1st Day of June, 2015 and which encumbers the following described property in the county of Escambia County, State of Florida, to wit: **15-4259-000**

Cert Holder:
IDE
IDE TECHNOLOGIES INC
3100 N29 COURTHOLLYWOOD, FL 33020

Property Owner:
ANDALA ENTERPRISES INC
641 BAYOU BLVD
PENSACOLA, FL 32503
LT 10 BLK 6 BAYOU GROVE S/D PB 2 P 87 OR 6926 P 1087 CA
141

has surrendered same in my office and made written application for tax deed in accordance with Florida Statutes. I certify that the following tax certificates, interest, ownership and encumbrance report fee, and Tax Collector's fees have been paid, or if the certificate is held by the County, all appropriate fees have been deposited.

Certificates owned by applicant and filed in connection with this application:

Certificate Year/Number	Account Number	Sale Date	Face Amount of Certificate	Interest	Total
2015/9796	15-4259-000	06/01/2015	107.55	22.59	130.14

Certificates redeemed by applicant or included (County) in connection with this tax deed application:

Certificate Year/Number	Account Number	Sale Date	Face Amount of Certificate	Tax Collector's Fee	Interest	Total
2016/8988	15-4259-000	06/01/2016	2,282.21	6.25	114.11	2,402.57

Amounts Certified by Tax Collector (Lines 1-7):

	Total Amount Paid
1. Total of all Certificates in Applicant's Possession and Cost of the Certificates Redeemed by Applicant	2,532.71
2. Total of Delinquent Taxes Paid by Tax Deed Applicant	0.00
3. Total of Current Taxes Paid by Tax Deed Applicant	2144.67
4. Ownership and Encumbrance Report Fee	200.00
5. Tax Deed Application Fee	175.00
6. Total Interest Accrued by Tax Collector Pursuant to Section 197.542, F.S.	
7. Total (Lines 1 - 6)	5,052.38

Amounts Certified by Clerk of Court (Lines 8-15):

	Total Amount Paid
8. Clerk of Court Statutory Fee for Processing Tax Deed	
9. Clerk of Court Certified Mail Charge	
10. Clerk of Court Advertising Charge	
11. Clerk of Court Recording Fee for Certificate of Notice	
12. Sheriff's Fee	
13. Interest Computed by Clerk of Court Pursuant to Section 197.542, F.S.	
14. Total (Lines 8 - 13)	
15. One-half Assessed Value of Homestead Property, if Applicable per F.S.	
16. Other Outstanding Certificates and Delinquent Taxes Not Included in this Application,	
17. Statutory (Opening) Bid; Total of Lines 7, 14, 15 (if applicable) and 16 (if	
18. Redemption Fee	6.25
19. Total Amount to Redeem	

Done this the 3rd day of May, 2017 Scott Lunsford, Tax Collector of Escambia County

Date of Sale: September 5, 2017

By *Candice Lewis*

*This certification must be surrendered to the Clerk of the Circuit Court no later than ten (10) days after this date.
15-4259-000 2015

APPLICATION FOR TAX DEED

Section 197.502, Florida Statutes

512
R. 12/16

Application Number: 1700252

To: Tax Collector of ESCAMBIA COUNTY, Florida

I,
IDE
IDE TECHNOLOGIES INC
3100 N29 COURT
HOLLYWOOD, FL 33020,

hold the listed tax certificate and hereby surrender the same to the Tax Collector and make tax deed application thereon:

Account Number	Certificate No.	Date	Legal Description
15-4259-000	2015/9796	06-01-2015	LT 10 BLK 6 BAYOU GROVE S/D PB 2 P 87 OR 6926 P 1087 CA 141

I agree to:

- pay any current taxes, if due and
- redeem all outstanding tax certificates plus interest not in my possession, and
- pay all delinquent and omitted taxes, plus interest covering the property.
- pay all Tax Collector's fees, ownership and encumbrance report costs, Clerk of the Court costs, charges and fees, and Sheriff's costs, if applicable.

Attached is the tax sale certificate on which this application is based and all other certificates of the same legal description which are in my possession.

Electronic signature on file
IDE
IDE TECHNOLOGIES INC
3100 N29 COURT
HOLLYWOOD, FL 33020

04-25-2017
Application Date

Applicant's signature



Chris Jones Escambia County Property Appraiser

- Real Estate Search
- Tangible Property Search
- Sale List
- Amendment 1/Portability Calculations

[Back](#)

← [Navigate Mode](#) [Account](#) [Reference](#) →

Printer Friendly Version

General Information

Reference: 000S009092010006
Account: 154259000
Owners: ANDALA ENTERPRISES INC
Mail: 641 BAYOU BLVD
 PENSACOLA, FL 32503
Situs: 3290 BAYOU DR 32505
Use Code: SINGLE FAMILY RESID
Taxing Authority: PENSACOLA CITY LIMITS
Tax Inquiry: [Open Tax Inquiry Window](#)
 Tax Inquiry link courtesy of Scott Lunsford
 Escambia County Tax Collector

Assessments

Year	Land	Imprv	Total	Cap Val
2016	\$43,190	\$67,383	\$110,573	\$110,573
2015	\$43,190	\$64,593	\$107,783	\$107,783
2014	\$43,190	\$60,667	\$103,857	\$100,234

[Disclaimer](#)

[Amendment 1/Portability Calculations](#)

★ [File for New Homestead Exemption Online](#)

Sales Data **MLS Listing #505218**

Sale Date	Book	Page	Value	Type	Official Records (New Window)
09/01/2015	7402	465	\$123,200	CT	View Instr
10/25/2012	6926	1087	\$125,000	WD	View Instr
08/1990	2931	509	\$100	WD	View Instr
08/1980	1468	716	\$57,900	WD	View Instr
01/1974	831	701	\$27,400	WD	View Instr
01/1971	525	530	\$100	WD	View Instr

Official Records Inquiry courtesy of Pam Childers
 Escambia County Clerk of the Circuit Court and Comptroller

2016 Certified Roll Exemptions

None

Legal Description

LT 10 BLK 6 BAYOU GROVE S/D PB 2 P 87 OR 7402 P 465 CA 141

Extra Features

FRAME BUILDING

Parcel Information [Launch Interactive Map](#)

Section Map Id: CA141

Approx. Acreage: 0.2205

Zoned: R-1A

Evacuation & Flood Information
[Open Report](#)

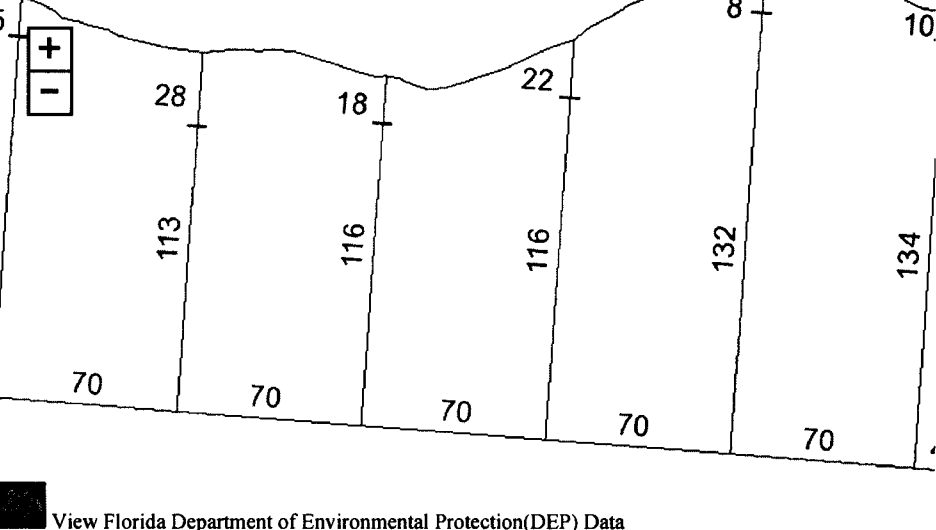

[View Florida Department of Environmental Protection \(DEP\) Data](#)

Buildings

Address: 3290 BAYOU DR, Year Built: 1953, Effective Year: 1975

Structural Elements

EXTERIOR WALL-BRICK-FACE/VENEER
FLOOR COVER-TILE/STAIN
 CONC/BRICK
FOUNDATION-WOOD/SUB FLOOR
HEAT/AIR-CENTRAL H/AC
INTERIOR WALL-DRYWALL-PLASTER
NO. PLUMBING FIXTURES-3
NO. STORIES-1
ROOF COVER-COMPOSITION SHG
ROOF FRAMING-GABLE
STORY HEIGHT-0
STRUCTURAL FRAME-WOOD FRAME

 Areas - 2360 Total SF
BASE AREA - 1294
BASE SEMI FIN - 168
GARAGE UNFIN - 288
OPEN PORCH FIN - 30
UTILITY UNF - 132
WOOD DECK FIN - 448

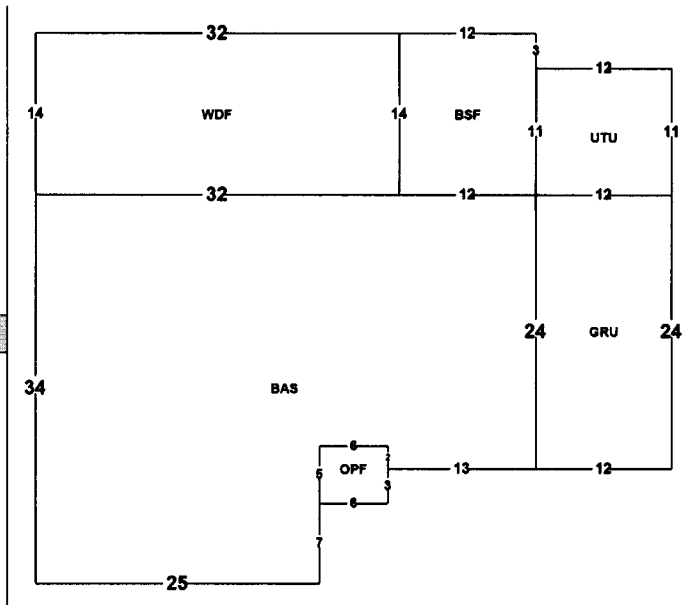

Images



2/22/16

The primary use of the assessment data is for the preparation of the current year tax roll. No responsibility or liability is assumed for inaccuracies or errors.

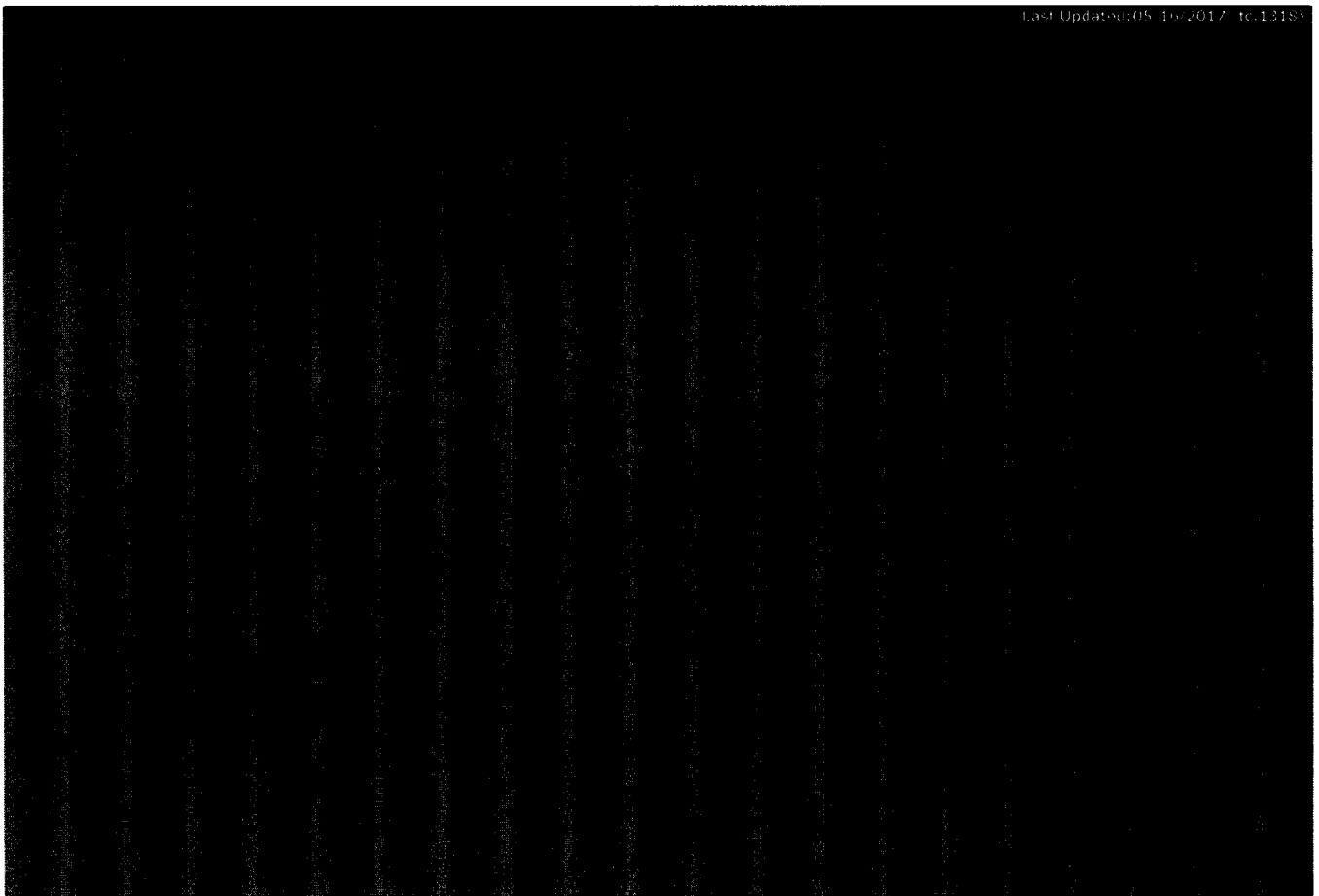

PAM CHILDERS
 CLERK OF THE CIRCUIT COURT
 ARCHIVES AND RECORDS
 CHILDSUPPORT
 CIRCUIT CIVIL
 CIRCUIT CRIMINAL
 COUNTY CIVIL
 COUNTY CRIMINAL
 DOMESTIC RELATIONS
 FAMILY LAW
 JURY ASSEMBLY
 JUVENILE
 MENTAL HEALTH
 MIS
 OPERATIONAL SERVICES
 PROBATE
 TRAFFIC



BRANCH OFFICES
ARCHIVES AND RECORDS
JUVENILE DIVISION
CENTURY

CLERK TO THE BOARD OF
 COUNTY COMMISSIONERS
 OFFICIAL RECORDS
 COUNTY TREASURY
 AUDITOR

COUNTY OF ESCAMBIA
OFFICE OF THE
CLERK OF THE CIRCUIT COURT

PAM CHILDERS, CLERK OF THE CIRCUIT COURT
Tax Certificate Redeemed From Sale
Account: 154259000 Certificate Number: 009796 of 2015

Payor: ANDALA ENTERPRISES INC 641 BAYOU BLVD PENSACOLA, FL 32503 Date
06/15/2017

Clerk's Check #	5503576959	Clerk's Total	\$483.75
Tax Collector Check #	1	Tax Collector's Total	\$5,437.56
		Postage	\$60.00
		Researcher Copies	\$0.00
		Total Received	\$5,981.31

Redeemed @ 5,353.70

PAM CHILDERS
 Clerk of the Circuit Court

Received By: _____
 Deputy Clerk

PAM CHILDERS
 CLERK OF THE CIRCUIT COURT
 ARCHIVES AND RECORDS
 CHILDSUPPORT
 CIRCUIT CIVIL
 CIRCUIT CRIMINAL
 COUNTY CIVIL
 COUNTY CRIMINAL
 DOMESTIC RELATIONS
 FAMILY LAW
 JURY ASSEMBLY
 JUVENILE
 MENTAL HEALTH
 MIS
 OPERATIONAL SERVICES
 PROBATE
 TRAFFIC



BRANCH OFFICES
ARCHIVES AND RECORDS
JUVENILE DIVISION
CENTURY

CLERK TO THE BOARD OF
 COUNTY COMMISSIONERS
 OFFICIAL RECORDS
 COUNTY TREASURY
 AUDITOR

COUNTY OF ESCAMBIA
OFFICE OF THE
CLERK OF THE CIRCUIT COURT

Case # 2015 TD 009796
Redeemed Date 06/15/2017

Name ANDALA ENTERPRISES INC 641 BAYOU BLVD PENSACOLA, FL 32503

Clerk's Total = TAXDEED	\$483.75
Due Tax Collector = TAXDEED	\$5,437.56
Postage = TD2	\$60.00
ResearcherCopies = TD6	\$0.00

• For Office Use Only

Date	Docket	Desc	Amount Owed	Amount Due	Payee Name
------	--------	------	-------------	------------	------------

FINANCIAL SUMMARY
 No Information Available - See Dockets

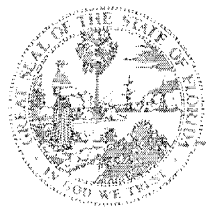

Pam Childers

Clerk of the Circuit Court and Comptroller, Escambia County

Clerk of Courts • County Comptroller • Clerk of the Board of County Commissioners • Recorder •

June 20, 2017

IDE TECHNOLOGIES INC
3100 N29 COURT
HOLLYWOOD FL 33020

Dear Certificate Holder:

The records of this office show that an application for a tax deed had been made on the property represented by the numbered certificate listed below. The property redeemed prior to sale; therefore your application fees are now refundable.

TAX CERT	APP FEES	INTEREST	TOTAL
2015 TD 009796	\$450.00	\$13.50	\$463.50

TOTAL \$463.50

Very truly yours,

PAM CHILDERS
Clerk of Circuit Court

By:

A handwritten signature in black ink, appearing to read "Emily Hogg".

Emily Hogg
Tax Deed Division

Southern Guaranty Title Company

4400 Bayou Boulevard, Suite 13B

Pensacola, Florida 32503

Telephone: 850-478-8121

Facsimile: 850-476-1437

17-439
Redeemed

OWNERSHIP AND ENCUMBRANCE REPORT

File No.: 13706

June 12, 2017

Escambia County Tax Collector
P.O. Box 1312
Pensacola, Florida 32591

Pursuant to your request, the Company has caused a search to be made of the Public Records of Escambia County, Florida, solely as revealed by records maintained from 06-08-1997, through 06-08-2017, and said search reveals the following:

1. THE GRANTEE(S) OF THE LAST DEED(S) OF RECORD IS:

Andala Enterprises, Inc.

2. The land covered by this Report is:

LEGAL DESCRIPTION IS ATTACHED HERETO AND MADE A PART HEREOF

3. The following unsatisfied mortgages, liens and judgments affecting the land covered by this Report appear of record:

SEE CONTINUATION PAGE ATTACHED HERETO AND MADE A PART HEREOF

4. Taxes:

SEE CONTINUATION PAGE ATTACHED HERETO AND MADE A PART HEREOF

The foregoing report is prepared and furnished for information only, is not intended to constitute or imply any opinion, warranty, guaranty, insurance, or similar assurance as to the status of title, and no determination has been made of the authenticity of any instrument described or referred to herein. The name search for the purposes of determining applicable judgments and liens is limited to the apparent record owner(s) shown herein, No attempt has been made to determine whether the land is subject to liens or assessments which are not shown as existing liens by the public records. The Company's liability hereunder shall not exceed the cost of this Report, or \$1,000.00 whichever is less.

THIS REPORT SHALL NOT BE USED FOR THE ISSUANCE OF TITLE INSURANCE.

Southern Guaranty Title Company

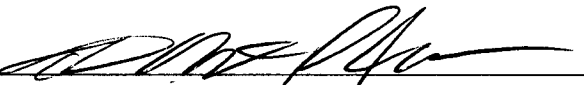
By: 

June 12, 2017

**OWNERSHIP AND ENCUMBRANCE REPORT
LEGAL DESCRIPTION**

File No.: 13706

June 12, 2017

Lot 10, Block 6, Bayou Grove Subdivision, as per plat thereof, recorded in Plat Book 2, Page 87, of the Public Records of Escambia County, Florida

**OWNERSHIP AND ENCUMBRANCE REPORT
CONTINUATION PAGE**

File No.: 13706

June 12, 2017

UNSATISFIED MORTGAGES, LIENS AND JUDGMENTS AFFECTING THE LAND COVERED BY THIS REPORT THAT APPEAR OF RECORD:

1. Code Enforcement Lien filed by Escambia County recorded in O.R. Book 7544, page 1128.
2. Taxes for the year 2014-2016 delinquent. The assessed value is \$110,573.00. Tax ID 15-4259-000.

PLEASE NOTE THE FOLLOWING:

- A. Subject to current year taxes.
- B. Taxes and assessments due now or in subsequent years.
- C. Subject to Easements, Restrictions and Covenants of record.
- D. Encroachments, overlaps, boundary line disputes, and any other matters which would be disclosed by an accurate survey and inspection of the premises.
- E. Oil, gas and mineral or any other subsurface rights of any kind or nature.

SOUTHERN GUARANTY TITLE COMPANY

4400 BAYOU BLVD., SUITE 13-B, CORDOVA SQUARE

PENSACOLA, FLORIDA 32503

TEL. (850) 478-8121 FAX (850) 476-1437

Email: rcsqt@aol.com

Scott Lunsford
Escambia County Tax Collector
P.O. Box 1312
Pensacola, FL 32591

CERTIFICATION: TITLE SEARCH FOR TDA

TAX DEED SALE DATE: 9-5-2017

TAX ACCOUNT NO.: 15-4259-000

CERTIFICATE NO.: 2015-9796

In compliance with Section 197.256, Florida Statutes, the following is a list of names and addresses of those persons, firms and/or agencies having legal interest in or claim against the above described property. The above referenced tax sale certificate is being submitted as proper notification of tax deed sale.

YES NO

- Notify City of Pensacola, P.O. Box 12910, 32521
221 Palafox Place, 4th Floor/
 Notify Escambia County, 190 Governmental Center, 32502
 Homestead for tax year.

Andala Enterprises, Inc.
641 Bayou Blvd.
Pensacola, FL 32503
and
P.O. Box 9414
Pensacola, FL 32513

Escambia County Code Enforcement
3363 West Park Place
Pensacola, FL 32505

Unknown Tenants
3290 Bayou Dr.
Pensacola, FL 32505

Certified and delivered to Escambia County Tax Collector,
this 12th day of June, 2017.

SOUTHERN GUARANTY TITLE COMPANY

by: Richard S. Combs, President

NOTE: The above listed addresses are based upon current information available, but said addresses are not guaranteed to be true or correct.

**IN THE CIRCUIT COURT OF THE FIRST JUDICIAL CIRCUIT
IN AND FOR ESCAMBIA COUNTY, FLORIDA
CIVIL ACTION**

CASE NO. 2014 CA 002235

MOTLEY, DWIGHT
Plaintiff

VS.

PERRY, CLAUDE J JR ; UNKNOWN HEIRS GRANTEES DEVISEES LIENORS
TRUSTEES AND CREDITORS OF CLAUDE PERRY JR
Defendant

CERTIFICATE OF TITLE

The undersigned, Pam Childers, Clerk of the Circuit Court, hereby certifies that a certificate of sale has been executed and filed in this action on August 21, 2015, for the property described herein and that no objections to the sale have been filed within the time allowed for filing objections.

The following property in Escambia County, Florida:

**Lot 10, Block 6, Bayou Grove Subdivision, according to the Plat thereof as recorded in Plat Book 2,
Page 87, of the Public Records of Escambia County, Florida.**

was sold to ANDALA ENTERPRISES, INC.
5201 North Davis Highway Pensacola, FL, 32503

WITNESS my hand and seal of the court this 1 day of September, 2015



Pam Childers
Clerk of the Circuit Court

BY: *[Signature]*
Deputy Clerk

Conformed copies to all parties

\$ 133,200.00

THE OFFICE OF ENVIRONMENTAL ENFORCEMENT
SPECIAL MAGISTRATE
IN AND FOR ESCAMBIA COUNTY, FLORIDA

ESCAMBIA COUNTY, FLORIDA

vs.

Case No.: CE 07-03-1056
Location: 1203 N Green Street
PR# 342S300640020064

Andala Enterprises, Inc.
5201 N Davis Highway
Pensacola, FL 32503

ORDER CERTIFYING FINES AND COSTS

THIS CAUSE was brought before the Office of the Environmental Enforcement Special Magistrate on Petitioner's Certification of Costs, pursuant to the Special Magistrate's Final Judgment of April 16, 2008; and the Special Magistrate having found the Respondent's predecessor in title in violation of Escambia County Code of Ordinances as set forth in that Final Judgment. Escambia County having given the Respondent notice of the fines and the Respondent having timely objected thereto, this hearing was held. At this hearing the parties stipulated as to the fines that are in addition to the costs of \$1,100.00 imposed by the Final Judgment of Special Magistrate dated April 16, 2008. THEREFORE, the Special Magistrate being otherwise fully advised in the premises; it is ORDERED, pursuant to Section 30-35 of the Escambia County Code of Ordinances, that the following itemized fines shall be imposed pursuant to the Final Judgment of the Special Magistrate dated April 16, 2008:

Itemized	Amount
Fines (\$25.00 per day 11/07/15 - 4/04/16)	\$ 2,680.00

which together with the previously imposed costs of \$1,100.00 makes a total of \$3,780.00.

DONE AND ORDERED at Escambia County, Florida, this 7th day of June, 2016.

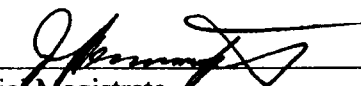

Special Magistrate
Office of Environmental Enforcement